



Sphere V Déco • Sphere C Déco
Sphere V Steel • Sphere C Steel

Dichiarazione di conformità UE
EU Declaration of Conformity
Declaration de Conformite UE
(DoC)



Il costruttore
The manufacturer
Le fabricant

Aico S.p.A.
Via A. Kupfer, 31
25036 Palazzolo s/O (Bs) – Italy
ph: +39 030 74 02 939, e-mail: info@ravelligroup.it

DICHIARA che la dichiarazione viene rilasciata sotto la propria responsabilità e si riferisce al seguente prodotto:

DECLARES that the DoC is issued under our sole responsibility and belongs to the following product:

DÉCLARE que la déclaration est délivré sous notre seule responsanilité et elle se refère au suivant produit:

Tipo di prodotto
Product type
Type de produit

Stufa a pellet
Pellet stove
Poêle à granulés de bois

Marchio
Trademark
Marque

Ravelli

Modello
Model
Modèle

**Sphere C Déco, Sphere C Steel, Sphere V Déco,
Sphere V Steel**

L'oggetto della dichiarazione di cui sopra è conforme alla pertinente normativa di armonizzazione dell'Unione:

The object of the declaration described above is in conformity with the relevant Union harmonisation legislation:

L'objet de la déclaration décrit ci-dessus est conforme à l'harmonisation de l'Union concernant la législation la directive:

- **2014/53/EU, RED**
- **2011/65/EU, 2015/863/EU, 2017/2102/EU, RoHS**
- **2009/125/EC, Ecodesign**

Sono state applicate le seguenti norme armonizzate e/o specifiche tecniche:

The following harmonised standards and/or technical specifications have been applied:

Les normes et les spécifications techniques harmonisées suivantes ont été appliquées:

EN 55014-1	EN 60335-1			
EN 55014-2	EN 60335-2-102	EN 50581	(EU) 2015/1185	ETSI EN 300220-1
EN 61000-3-2	EN 62233			
EN 61000-3-3				

Palazzolo Sull'Oglio (BS), ITALY
31/01/2020

(Claudio Mezzalana, Operations Manager)

	SCHEDA PRODOTTO	PRODUCT DATASHEET
	FICHE DE PRODUIT	PRODUCTKAART
	PRODUKTDATENBLATT	FICHA DEL PRODUCTO

EU 2015/1186

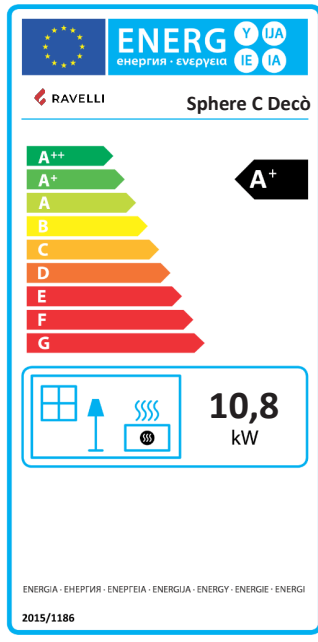
 <p>ENERGIA - ЕНЕРГИЯ - ΕΝΕΡΓΕΙΑ - ENERGIJA - ENERGY - ENERGIE - ENERGI</p> <p>2015/1186</p>	Marca / Trademark / Marque / Merk / Marke / Marca	Ravelli	
	Modello / Model / Modèle / Model / Modell / Modelo	Sphere C Decò	
	Classe di efficienza energetica / Energy Efficiency class / Classe d'Efficacité Énergétique / Energie-efficiëntieklasse / Energieeffizienzklasse / Clase de eficiencia energética	A+	
	Potenza termica diretta / Direct thermal power / Puissance thermique directe / Directe warmteafgifte / Direkte Wärmeleistung / Potencia calorífica directa	10,8 kW	
	Potenza termica indiretta / Indirect thermal power / Puissance thermique indirecte / Indirecte warmteafgifte / Indirekte Wärmeleistung / Potencia calorífica indirecta	--	
	Indice di efficienza energetica / Energy Efficiency Index / Indice de eficiencia energética / Energie-efficiëntie-index / Energieeffizienzindex / Índice de eficiencia energética	125	
	Efficienza utile (Potenza nominale) / Useful efficiency (Nominal power) / Rendement utile (puissance nominale) / Nuttig rendement (bij nominale) / Brennstoff-Energieeffizienz (Nennwärmeleistung) / Eficiencia energética útil (potencia nominal)	89 %	
	Efficienza utile (Potenza ridotta) / Useful efficiency (Reduced power) / Rendement utile (puissance minimale) / Nuttig rendement (bij minimale) / Brennstoff-Energieeffizienz (Mindestlast) / Eficiencia energética útil (potencia minima)	91,8 %	
	Rispettare le avvertenze e le indicazioni di installazione e manutenzione periodica riportate nel manuale di istruzioni. / Comply with the warnings and instructions concerning installation and routine maintenance provided in the instruction manual. / Respecter les avertissements et les indications sur l'installation et l'entretien périodique fournis dans le manuel d'instructions. / Neem de waarschuwingen en instructies voor installatie en periodiek onderhoud in acht zoals aangegeven in de hoofdstukken van de gebruiksaanwijzing. / Beachten Sie die Warnungen und Hinweise betreffend die Installation und regelmäßige Wartung in der Bedienungsanleitung. / Respete las advertencias y las indicaciones de instalación y mantenimiento periódico, detalladas en los capítulos del manual de instrucciones.		

	SCHEDA PRODOTTO	PRODUCT DATASHEET
	FICHE DE PRODUIT	PRODUCTKAART
	PRODUKTDATENBLATT	FICHA DEL PRODUCTO

EU 2015/1186

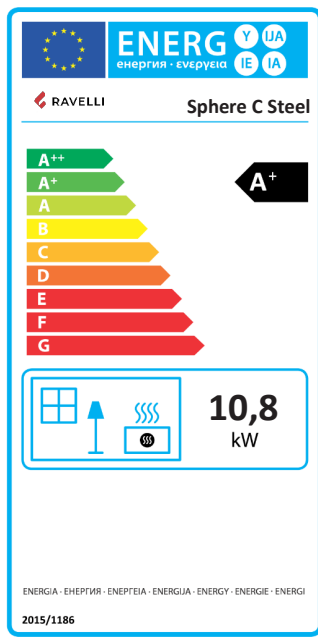
 <p>ENERGIA - ЕНЕРГИЯ - ΕΝΕΡΓΕΙΑ - ENERGIJA - ENERGY - ENERGIE - ENERGI</p> <p>2015/1186</p>	Marca / Trademark / Marque / Merk / Marke / Marca	Ravelli	
	Modello / Model / Modèle / Model / Modell / Modelo	Sphere C Steel	
	Classe di efficienza energetica / Energy Efficiency class / Classe d'Efficacité Énergétique / Energie-efficiëntieklasse / Energieeffizienzklasse / Clase de eficiencia energética	A+	
	Potenza termica diretta / Direct thermal power / Puissance thermique directe / Directe warmteafgifte / Direkte Wärmeleistung / Potencia calorífica directa	10,8 kW	
	Potenza termica indiretta / Indirect thermal power / Puissance thermique indirecte / Indirecte warmteafgifte / Indirekte Wärmeleistung / Potencia calorífica indirecta	--	
	Indice di efficienza energetica / Energy Efficiency Index / Indice de eficiencia energética / Energie-efficiëntie-index / Energieeffizienzindex / Índice de eficiencia energética	125	
	Efficienza utile (Potenza nominale) / Useful efficiency (Nominal power) / Rendement utile (puissance nominale) / Nuttig rendement (bij nominale) / Brennstoff-Energieeffizienz (Nennwärmeleistung) / Eficiencia energética útil (potencia nominal)	89 %	
	Efficienza utile (Potenza ridotta) / Useful efficiency (Reduced power) / Rendement utile (puissance minimale) / Nuttig rendement (bij minimale) / Brennstoff-Energieeffizienz (Mindestlast) / Eficiencia energética útil (potencia minima)	91,8 %	
	Rispettare le avvertenze e le indicazioni di installazione e manutenzione periodica riportate nel manuale di istruzioni. / Comply with the warnings and instructions concerning installation and routine maintenance provided in the instruction manual. / Respecter les avertissements et les indications sur l'installation et l'entretien périodique fournis dans le manuel d'instructions. / Neem de waarschuwingen en instructies voor installatie en periodiek onderhoud in acht zoals aangegeven in de hoofdstukken van de gebruiksaanwijzing. / Beachten Sie die Warnungen und Hinweise betreffend die Installation und regelmäßige Wartung in der Bedienungsanleitung. / Respete las advertencias y las indicaciones de instalación y mantenimiento periódico, detalladas en los capítulos del manual de instrucciones.		

	SCHEDA PRODOTTO	PRODUCT DATASHEET
	FICHE DE PRODUIT	PRODUCTKAART
	PRODUKTDATENBLATT	FICHA DEL PRODUCTO

EU 2015/1186

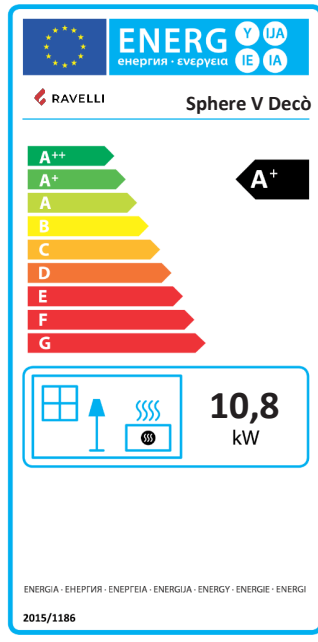
 <p>RAVELLI Sphere V Decò</p> <p>A+</p> <p>10,8 kW</p> <p>ENERGIA - ЕНЕРГИЯ - ΕΝΕΡΓΕΙΑ - ENERGIJA - ENERGY - ENERGIE - ENERGI 2015/1186</p>	Marca / Trademark / Marque / Merk / Marke / Marca	Ravelli
	Modello / Model / Modèle / Model / Modell / Modelo	Sphere V Decò
	Classe di efficienza energetica / Energy Efficiency class / Classe d'Efficacité Énergétique / Energie-efficiëntieklasse / Energieeffizienzklasse / Clase de eficiencia energética	A+
	Potenza termica diretta / Direct thermal power / Puissance thermique directe / Directe warmteafgifte / Direkte Wärmeleistung / Potencia calorífica directa	10,8 kW
	Potenza termica indiretta / Indirect thermal power / Puissance thermique indirecte / Indirecte warmteafgifte / Indirekte Wärmeleistung / Potencia calorífica indirecta	--
	Indice di efficienza energetica / Energy Efficiency Index / Indice de eficiencia energética / Energie-efficiëntie-index / Energieeffizienzindex / Índice de eficiencia energética	125
	Efficienza utile (Potenza nominale) / Useful efficiency (Nominal power) / Rendement utile (puissance nominale) / Nuttig rendement (bij nominale) / Brennstoff-Energieeffizienz (Nennwärmeleistung) / Eficiencia energética útil (potencia nominal)	89 %
	Efficienza utile (Potenza ridotta) / Useful efficiency (Reduced power) / Rendement utile (puissance minimale) / Nuttig rendement (bij minimale) / Brennstoff-Energieeffizienz (Mindestlast) / Eficiencia energética útil (potencia mínima)	91,8 %
	Rispettare le avvertenze e le indicazioni di installazione e manutenzione periodica riportate nel manuale di istruzioni. / Comply with the warnings and instructions concerning installation and routine maintenance provided in the instruction manual. / Respecter les avertissements et les indications sur l'installation et l'entretien périodique fournis dans le manuel d'instructions. / Neem de waarschuwingen en instructies voor installatie en periodiek onderhoud in acht zoals aangegeven in de hoofdstukken van de gebruiksaanwijzing. / Beachten Sie die Warnungen und Hinweise betreffend die Installation und regelmäßige Wartung in der Bedienungsanleitung. / Respete las advertencias y las indicaciones de instalación y mantenimiento periódico, detalladas en los capítulos del manual de instrucciones.	

	SCHEDA PRODOTTO	PRODUCT DATASHEET
	FICHE DE PRODUIT	PRODUCTKAART
	PRODUKTDATENBLATT	FICHA DEL PRODUCTO

EU 2015/1186

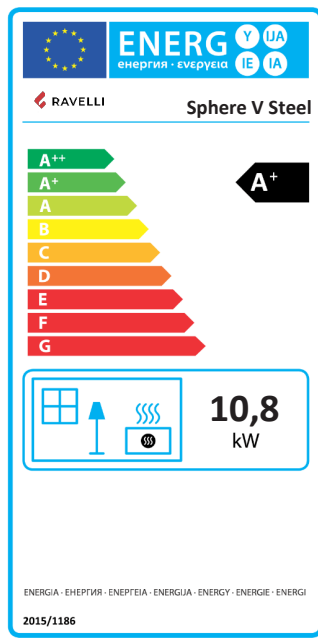
 <p>RAVELLI Sphere V Steel</p> <p>A+</p> <p>10,8 kW</p> <p>ENERGIA - ЕНЕРГИЯ - ΕΝΕΡΓΕΙΑ - ENERGIJA - ENERGY - ENERGIE - ENERGI 2015/1186</p>	Marca / Trademark / Marque / Merk / Marke / Marca	Ravelli
	Modello / Model / Modèle / Model / Modell / Modelo	Sphere V Steel
	Classe di efficienza energetica / Energy Efficiency class / Classe d'Efficacité Énergétique / Energie-efficiëntieklasse / Energieeffizienzklasse / Clase de eficiencia energética	A+
	Potenza termica diretta / Direct thermal power / Puissance thermique directe / Directe warmteafgifte / Direkte Wärmeleistung / Potencia calorífica directa	10,8 kW
	Potenza termica indiretta / Indirect thermal power / Puissance thermique indirecte / Indirecte warmteafgifte / Indirekte Wärmeleistung / Potencia calorífica indirecta	--
	Indice di efficienza energetica / Energy Efficiency Index / Indice de eficiencia energética / Energie-efficiëntie-index / Energieeffizienzindex / Índice de eficiencia energética	125
	Efficienza utile (Potenza nominale) / Useful efficiency (Nominal power) / Rendement utile (puissance nominale) / Nuttig rendement (bij nominale) / Brennstoff-Energieeffizienz (Nennwärmeleistung) / Eficiencia energética útil (potencia nominal)	89 %
	Efficienza utile (Potenza ridotta) / Useful efficiency (Reduced power) / Rendement utile (puissance minimale) / Nuttig rendement (bij minimale) / Brennstoff-Energieeffizienz (Mindestlast) / Eficiencia energética útil (potencia mínima)	91,8 %
	Rispettare le avvertenze e le indicazioni di installazione e manutenzione periodica riportate nel manuale di istruzioni. / Comply with the warnings and instructions concerning installation and routine maintenance provided in the instruction manual. / Respecter les avertissements et les indications sur l'installation et l'entretien périodique fournis dans le manuel d'instructions. / Neem de waarschuwingen en instructies voor installatie en periodiek onderhoud in acht zoals aangegeven in de hoofdstukken van de gebruiksaanwijzing. / Beachten Sie die Warnungen und Hinweise betreffend die Installation und regelmäßige Wartung in der Bedienungsanleitung. / Respete las advertencias y las indicaciones de instalación y mantenimiento periódico, detalladas en los capítulos del manual de instrucciones.	

DECLARATION OF PERFORMANCE

Declaration of performance according to Regulation (EU) 305/2011

n. : 229CPR13.07



- Unique identification code of the product type:
30018HR03, residential space heating appliance fired by wood pellets
EN 14785:2006
- Type, batch or serial number or any other element allowing identification of the construction product as required under Art. 11(4):
Sphere C Decò
- Intended use or uses of the construction product, in accordance with the applicable harmonised technical specification, as foreseen by the manufacturer:
Residential space heating appliance fired by wood pellets
- Name, registered trade name or registered trademark and contact address of the manufacturer as required by Art. 11 (5):
Ravelli
Aico S.p.A.
Via A. Kupfer, 31
25036 Palazzolo s/O (Bs) Italia
- Where applicable, name and contact address of the authorised representative whose mandate covers the tasks specified in Article 12(2):

- System or systems of assessment and verification of constancy of performance of the construction product as set out in Annex V:
System 3, System 4
- In case of the declaration of performance concerning a construction product covered by a harmonised standard:
The notified laboratory TÜV Rheinland Energy GmbH (NB 2456) performed the determination of the product type on the basis of type testing under system 3 and issued test report K28502020T1
- Declared performances:

Harmonized technical specification:	EN 14785:2006
Essential characteristics	Performance
Fire safety	
Reaction to fire	A1
Distance to combustible materials	Minimum distances (mm): rear = 100 sides = 200 front = 800 ceiling = -- floor = 0
Risk of burning fuel falling out	Pass
Emission of combustion products (at 13% of O₂)	Nominal heat output CO 0,002 % - 29 mg/Nm³ NOx 146 mg/Nm³ OGC 1 mg/Nm³ PM 14 mg/Nm³ Reduced heat output CO 0,020 % - 248 mg/Nm³ OGC 9 mg/Nm³
Surface temperature	Pass
Electrical safety	Pass
Cleanability	Pass
Maximum operating pressure	--
Flue gas temperature at nominal heat output	188 °C
Mechanical resistance(to carry a chimney/flue)	NPD
Nominal heat output	10,8 kW
Room heating output	10,8 kW
Water heating output	--
Efficiency	η 89 % Nominal heat output η 91,8 % Reduced heat output

- The performance of the product identified in points 1 and 2 is in conformity with the declared performance in point 8. This declaration of performance is issued under the sole responsibility of the manufacturer identified in point 4.

Signed for and on behalf of the manufacturer **Claudio Mezzalana, Operations Manager**

Place **Palazzolo sull'Oglio**

Date **22/10/2020**

Sign

DECLARATION OF PERFORMANCE

Declaration of performance according to Regulation (EU) 305/2011



n. : 227CPR13.07

- Unique identification code of the product type:
30013HR01, residential space heating appliance fired by wood pellets
EN 14785:2006
- Type, batch or serial number or any other element allowing identification of the construction product as required under Art. 11(4):
Sphere C Steel
- Intended use or uses of the construction product, in accordance with the applicable harmonised technical specification, as foreseen by the manufacturer:
Residential space heating appliance fired by wood pellets
- Name, registered trade name or registered trademark and contact address of the manufacturer as required by Art. 11 (5):
Ravelli
Aico S.p.A.
Via A. Kupfer, 31
25036 Palazzolo s/O (Bs) Italia
- Where applicable, name and contact address of the authorised representative whose mandate covers the tasks specified in Article 12(2):

- System or systems of assessment and verification of constancy of performance of the construction product as set out in Annex V:
System 3, System 4
- In case of the declaration of performance concerning a construction product covered by a harmonised standard:
The notified laboratory TÜV Rheinland Energy GmbH (NB 2456) performed the determination of the product type on the basis of type testing under system 3 and issued test report K28502020T1
- Declared performances:

Harmonized technical specification:	EN 14785:2006
Essential characteristics	Performance
Fire safety	
Reaction to fire	A1
Distance to combustible materials	Minimum distances (mm): rear = 100 sides = 200 front = 800 ceiling = -- floor = 0
Risk of burning fuel falling out	Pass
Emission of combustion products (at 13% of O ₂)	Nominal heat output CO 0,002 % - 29 mg/Nm ³ NOx 146 mg/Nm ³ OGC 1 mg/Nm ³ PM 14 mg/Nm ³ Reduced heat output CO 0,020 % - 248 mg/Nm ³ OGC 9 mg/Nm ³
Surface temperature	Pass
Electrical safety	Pass
Cleanability	Pass
Maximum operating pressure	--
Flue gas temperature at nominal heat output	188 °C
Mechanical resistance(to carry a chimney/flue)	NPD
Nominal heat output	10,8 kW
Room heating output	10,8 kW
Water heating output	--
Efficiency	η 89 % Nominal heat output η 91,8 % Reduced heat output

- The performance of the product identified in points 1 and 2 is in conformity with the declared performance in point 8. This declaration of performance is issued under the sole responsibility of the manufacturer identified in point 4.

Signed for and on behalf of the manufacturer **Claudio Mezzalana, Operations Manager**

Place **Palazzolo sull'Oglio**

Date **22/10/2020**

Sign

DECLARATION OF PERFORMANCE

Declaration of performance according to Regulation (EU) 305/2011



n. : 228CPR13.07

- Unique identification code of the product type:
20043HR03, residential space heating appliance fired by wood pellets
EN 14785:2006
- Type, batch or serial number or any other element allowing identification of the construction product as required under Art. 11(4):
Sphere V Decò
- Intended use or uses of the construction product, in accordance with the applicable harmonised technical specification, as foreseen by the manufacturer:
Residential space heating appliance fired by wood pellets
- Name, registered trade name or registered trademark and contact address of the manufacturer as required by Art. 11 (5):
Ravelli
Aico S.p.A.
Via A. Kupfer, 31
25036 Palazzolo s/O (Bs) Italia
- Where applicable, name and contact address of the authorised representative whose mandate covers the tasks specified in Article 12(2):

- System or systems of assessment and verification of constancy of performance of the construction product as set out in Annex V:
System 3, System 4
- In case of the declaration of performance concerning a construction product covered by a harmonised standard:
The notified laboratory TÜV Rheinland Energy GmbH (NB 2456) performed the determination of the product type on the basis of type testing under system 3 and issued test report K28502020T1
- Declared performances:

Harmonized technical specification:	EN 14785:2006
Essential characteristics	Performance
Fire safety	
Reaction to fire	A1
Distance to combustible materials	Minimum distances (mm): rear = 100 sides = 200 front = 800 ceiling = -- floor = 0
Risk of burning fuel falling out	Pass
Emission of combustion products (at 13% of O ₂)	Nominal heat output CO 0,002 % - 29 mg/Nm ³ NOx 146 mg/Nm ³ OGC 1 mg/Nm ³ PM 14 mg/Nm ³ Reduced heat output CO 0,020 % - 248 mg/Nm ³ OGC 9 mg/Nm ³
Surface temperature	Pass
Electrical safety	Pass
Cleanability	Pass
Maximum operating pressure	--
Flue gas temperature at nominal heat output	188 °C
Mechanical resistance(to carry a chimney/flue)	NPD
Nominal heat output	10,8 kW
Room heating output	10,8 kW
Water heating output	--
Efficiency	η 89 % Nominal heat output η 91,8 % Reduced heat output

- The performance of the product identified in points 1 and 2 is in conformity with the declared performance in point 8. This declaration of performance is issued under the sole responsibility of the manufacturer identified in point 4.

Signed for and on behalf of the manufacturer **Claudio Mezzalira, Operations Manager**

Place **Palazzolo sull'Oglio**

Date **22/10/2020**

Sign

DECLARATION OF PERFORMANCE

Declaration of performance according to Regulation (EU) 305/2011



n. : 226CPR13.07

- Unique identification code of the product type:
20030HR01, residential space heating appliance fired by wood pellets
EN 14785:2006
- Type, batch or serial number or any other element allowing identification of the construction product as required under Art. 11(4):
Sphere V Steel
- Intended use or uses of the construction product, in accordance with the applicable harmonised technical specification, as foreseen by the manufacturer:
Residential space heating appliance fired by wood pellets
- Name, registered trade name or registered trademark and contact address of the manufacturer as required by Art. 11 (5):
Ravelli
Aico S.p.A.
Via A. Kupfer, 31
25036 Palazzolo s/O (Bs) Italia
- Where applicable, name and contact address of the authorised representative whose mandate covers the tasks specified in Article 12(2):

- System or systems of assessment and verification of constancy of performance of the construction product as set out in Annex V:
System 3, System 4
- In case of the declaration of performance concerning a construction product covered by a harmonised standard:
The notified laboratory TÜV Rheinland Energy GmbH (NB 2456) performed the determination of the product type on the basis of type testing under system 3 and issued test report K28502020T1
- Declared performances:

Harmonized technical specification:	EN 14785:2006
Essential characteristics	Performance
Fire safety	
Reaction to fire	A1
Distance to combustible materials	Minimum distances (mm): rear = 100 sides = 200 front = 800 ceiling = -- floor = 0
Risk of burning fuel falling out	Pass
Emission of combustion products (at 13% of O ₂)	Nominal heat output CO 0,002 % - 29 mg/Nm ³ NOx 146 mg/Nm ³ OGC 1 mg/Nm ³ PM 14 mg/Nm ³ Reduced heat output CO 0,020 % - 248 mg/Nm ³ OGC 9 mg/Nm ³
Surface temperature	Pass
Electrical safety	Pass
Cleanability	Pass
Maximum operating pressure	--
Flue gas temperature at nominal heat output	188 °C
Mechanical resistance(to carry a chimney/flue)	NPD
Nominal heat output	10,8 kW
Room heating output	10,8 kW
Water heating output	--
Efficiency	η 89 % Nominal heat output η 91,8 % Reduced heat output

- The performance of the product identified in points 1 and 2 is in conformity with the declared performance in point 8. This declaration of performance is issued under the sole responsibility of the manufacturer identified in point 4.

Signed for and on behalf of the manufacturer **Claudio Mezzalana, Operations Manager**

Place **Palazzolo sull'Oglio**

Date **22/10/2020**

Sign

Preface

Dear Customer, We would like to thank you for choosing one of our stoves.

We invite you to read this manual carefully, before starting installation and use, so that you are able to benefit from all of its characteristics better and in full safety. It contains all necessary information for correct installation, start-up, operation, cleaning, maintenance, etc.

Keep this manual in a suitable location, do not discard it without reading it.

Incorrect installation, maintenance and improper use of the product relieve the Manufacturer of all liability deriving from use of the stove.

For further information and requirements contact your Ravelli-authorized Technical Assistance Centre.

All rights reserved. No part of this instructions manual can be reproduced or transmitted through any electronic or mechanical means, including photocopies, recordings or any other storage system, for other purposes that are not exclusively use by the buyer's staff, without the express written consent of the Manufacturer.

Sommaro

Preface.....	11
IDENTIFICATION	14
Stove identification	14
Manufacturer identification	14
Reference standards	14
Remote control: Synthetic Declaration of Conformity (DoC)	14
Label	14
WARRANTY	15
Certificate of warranty.....	15
Warranty conditions.....	15
Registration of warranty	15
Info and problems	15
GENERAL INFORMATION	16
Supply and safe-keeping	16
Language	16
Symbols used in the manual	16
SAFETY MEASURES	16
General safety warnings	16
Residual risks	17
DESCRIPTION OF THE STOVE.....	18
Intended use	18
Reasonably foreseeable incorrect use	18
Obligations and forbidden actions	19
Characteristics of the fuel	20
Non-permitted fuels.....	20
TECHNICAL CHARACTERISTICS	21
Technical diagram Sphere V Déco e Sphere V Steel	22
Technical diagram Sphere C Déco e Sphere C Steel.....	23
Main parts.....	24
Automatic cleaning system.....	25
Recharge the fuel	25
Doors opening	25
User training	25
SHIPPING AND INSTALLATION	28
Safety warnings for transportation and installation	28
Set-ups for the smoke evacuation system	29
Installation	30
CONNECTIONS	33
Chimney connection	33
Ducting	34
Connection of external probe or thermostat	34
Testing and commissioning	35
Electric scheme Sphere C Déco e Sphere C Steel	35
Electric scheme Sphere V Déco e Sphere V Steel.....	36
CONTROLS AND USE.....	37
Control panel description.....	37
Handheld touch radio initialization	37
Description of the handheld set.....	38
Description of the display	38
Time and date setting	39
PROCEDURES FOR USE	40
Checks prior to start-up	40
Feed screw loading	40
Switching the appliance on and off.....	40
Failed ignition	41
Setting operating temperature and power:	41

OPERATING PHASES OF THE APPLIANCE	41
<i>Sequence of ignition phases</i>	41
<i>Modulation</i>	41
<i>Description of menu functions</i>	41
<i>Setting</i>	44
<i>Double ducting</i>	46
<i>Stove phase general layout</i>	50
MAINTENANCE	53
<i>Safety warnings for maintenance</i>	53
<i>Cleaning</i>	53
<i>Extraordinary maintenance</i>	55
<i>Failure cases</i>	58
STORAGE AND DISPOSAL	61
<i>Disposal</i>	61
TROUBLESHOOTING	61
<i>The stove does not work</i>	61
<i>Difficult lighting</i>	61
<i>Smoke leakage</i>	61
<i>The glass gets dirty easily</i>	61
<i>Downtime (end of season)</i>	61

IDENTIFICATION

Stove identification

Type of product	PELLET STOVE
Trademark	Ravelli
Model	Sphere V Déco - Sphere C Déco - Sphere V Steel - Sphere C Steel

Manufacturer identification

Manufacturer	Aico S.p.A. Via Consorzio Agrario, 3/D - 25032 Chiari (BS) - Italy T. + 39 030 7402939 info@ravelligroup.it www.ravelligroup.it
--------------	--

Reference standards

The Sphere V Déco, Sphere C Déco, Sphere V Steel, Sphere C Steel stoves that this manual refers to are compliant with the regulation:

305/2011, CONSTRUCTION PRODUCT REGULATION

and the following directives

2014/53/EU (RED)

2011/65/EU 2015/863/EU, 2017/2102/EU, (RoHS)

2009/125/EC (Ecodesign)

And the following harmonised standards and/or technical specifications have been applied:

EN 14785; EN 55014-1; EN 55014-2; EN 61000-3-2; EN 61000-3-3; EN 60335-1; EN 60335-2-102; EN 62233; EN 50581; ETSI EN 300220-1

All local regulations, including those referring to national and European standards, must be respected when installing the appliance.

Remote control: Synthetic Declaration of Conformity (DoC)

The manufacturer Aico S.p.A. declares that the Remote Control, with the Ravelli brand and model PNET00003 (Palm Touch) is in conformity with the relevant Union harmonisation legislation: 2014/53/EU (RED), and that the following harmonised standards and/or technical specifications have been applied: ETSI EN 301 489-3, ETSI EN 301 489-1, EN 60950-1 A11+A12+AC+A2, EN 62479.

These declarations can be found in full format on the website www.ravelligroup.it.

Label

The following symbols are used on the label:

$P_{IN,nom}$	Heat input power (max)	$P_{IN,part}$	Heat input power (min)
P_{nom}	Nominal power	P_{part}	Reduced power
CO_{nom}	CO at nominal power	CO_{part}	CO at reduced power
η_{nom}	Efficiency at nominal power	η_{part}	Efficiency at reduced power
p_{nom}	Minimum draught at nominal power	T	Flue gas temperature at nominal power
230 V - 50 Hz	Alimentation		
Distance to combustible materials			
d_{S-L}	Left side	d_C	Ceiling
d_{S-R}	Right side	d_F	Front
d_R	Rear	d_B	Floor

n.d.: undeclared data

Model: Sphere C Steel

APPARECCHIO PER IL RISCALDAMENTO DOMESTICO ALIMENTATO A PELLET DI LEGNO RESIDENTIAL SPACE HEATING APPLIANCE FIRED BY WOOD PELLETS APPAREIL DE CHAUFFAGE DOMESTIQUE A CONVECTION A GRANULES DE BOIS APARATO DE CALEFACCION DOMESTICA ALIMENTADO CON PELLETS DE MADERA HUISSHOUDELIJKE RUIMTEVERWARMINGSTOESTELLEN GESTOOKT MET GEPEEST HOUT RAUMHEIZER ZUR VERFEUERUNG VON HOLZPELLETS			
$P_{IN,nom}$	12,1 kW	$P_{IN,part}$	5,3 kW
P_{nom}	10,8 kW	P_{part}	4,9 kW
$CO_{nom}(13\%O_2)$	0,002 %	$CO_{part}(13\%O_2)$	0,020 %
η_{nom}	89,0 %	η_{part}	91,8 %
p_{nom}	10 Pa	$0,1 \text{ mbar}$	
T_{nom}	188 °C	W	250 W
230 V 50 Hz			
Usare solo il combustibile raccomandato: Use only recommended fuel: Utilizer seulement les combustibles recommandés: Use solo el combustible recomendado: Gebruik alleen de aanbevolen brandstof: Nur empfohlene Brennmaterial verwenden:		Pellet di legno Wood pellet Granulee de bois Pellet de madera Houtpellet Holzpellets Ø 6 mm	
Leggere le istruzioni d'uso / Read and follow the operating manual / Lire et suivre le mode d'emploi / Lea y respete le manual de operacion / Lees en volg de handleiding voor bediening / Bitte lesen und befolgen Sie die Montage und Nutzungsanweisungen			
Distanza minima da materiali infiammabili Minimum distance from flammable materials Distance moindre de matériels inflammables Distancia minima de materiales inflamables Minimale afstand van brandbare materialen Mindestabstand zu brennbaren Materialien	d_{S-R} d_{S-L} d_R d_C d_F d_B	200 mm 200 mm 100 mm n.d. mm 800 mm 0 mm	

D.o.P. n° 227CPR13.07 (Notified Body 2456)

EN 14785:2006

Anno di produzione: 2020



WARRANTY

Certificate of warranty

Ravelli thanks you for the trust granted with the purchase of one of its products and invites the purchaser to:

- read the installation, use and maintenance instructions for the product;
- read the warranty conditions contained below.

Warranty conditions

The warranty for the Customer is acknowledged by the Dealer under the terms of law.

The Dealer acknowledges the warranty only if the product has not been tampered with and only if it has been installed in accordance with the Manufacturer's instructions.

The limited warranty covers manufacturing material defects, as long as the product has not broken due to an incorrect use, negligence, incorrect connection, tampering, installation errors.

The warranty becomes null and void even if only one requirement in this manual is not complied with.

The following are not covered by warranty:

- the combustion chamber refractory stones;
- the door glass;
- the gaskets;
- the paint job;
- the stainless steel or cast iron combustion grille;
- the resistance;
- the Majolica cladding;
- the aesthetic parts;
- any damages caused by unsuitable installation and/or use of the product and/or shortcomings on the part of the customer.

The use of poor quality pellet or any other unauthorised fuel may damage the product's components, cause its warranty to be voided and as a result eliminate the connected manufacturer liability.

It is therefore recommended to use good quality pellet that fulfils the requirements listed in the dedicated chapter.

All damages caused by transportation are not recognised, for this reason it is recommended to carefully check goods upon receipt, immediately warning the reseller of any damage.

Registration of warranty



To activate the warranty, it is necessary to register the product on the Guarantee Portal on the website www.ravelligroup.it, by entering your data and the purchase receipt.

Info and problems

Dealers authorised by Ravelli use a trained Technical Service Centre network to meet the Customer's requirements. For any information or request for assistance, please contact your Dealer or the Technical Service Centre.

GENERAL INFORMATION

Supply and safe-keeping

The manual is supplied in printed format.

Keep this manual safe, with the stove, so that the user can consult it easily.

The manual is an integral part, for safety reasons, therefore:

- **it must be kept intact** (in full). If it gets lost or ruined it is necessary to immediately ask for a new copy:
- **it must be kept with the stove until demolition** (including relocation, sale, rental, lease, etc....).

The Manufacturer will not be held liable for improper use of the stove and/or damage caused by operations that are not set forth in the technical documentation.



Language

The original manual was written in Italian.

Any translations into additional languages must be carried out based on the original instructions.

The Manufacturer is liable for the information contained in the original instructions; the translations into different languages cannot be fully verified therefore if any inconsistency arises it will be necessary to follow the text in the original language or contact our Technical Documentation Office.

Symbols used in the manual

symbol	definition
	This symbol is used to identify particularly important information in the manual. This information also concerns the safety of users involved in using the stove.
	This symbol is used to identify important warnings for the safety of the user and/or the stove.

SAFETY MEASURES

General safety warnings

 Read this instructions manual carefully before stove installation and use. Failure to observe the instructions set forth herein can void the warranty and/or cause damage to property and/or people.

 Stove installation, system verification, operation verification and initial calibration must be carried out exclusively by qualified and authorised staff.

 The stove needs to be connected to a single chimney that guarantees the draught declared by the Manufacturer and observes the installation regulations that apply to the installation site.

 The room where the stove is installed must have an air intake.

 The stove must not be used as an incinerator or differently from its purpose

 Do not use any fuel other than fire pellet. It is strictly forbidden to use liquid fuels.

 It is prohibited to use the stove with the door or ash drawer open or the glass broken.

 Do not touch the hot surfaces of the stove without suitable protective equipment, to avoid getting burned. When it is running, the outer surfaces reach hot temperatures to the touch.

 It is forbidden to make unauthorised changes to the stove.

 Before using the stove it is necessary to know the position and function of the controls.

 If the chimney catches fire you must call the fire brigade.

 Only use original spare parts. Any tampering and/or replacements that have not been authorised by Ravelli can pose a danger to the user's safety.

 In the event of particularly adverse weather conditions, the safety systems could intervene and switch off the stove. In any case, do not disable the safety systems.

Residual risks

The stove was designed so as to guarantee the user's essential safety requirements.

Safety was integrated into the stove's design and construction as much as possible.

For every residual risk there is a description of the risk and the zone or part that it applies to (unless the risk applies to the entire stove overall). Procedure-related information is also provided on how to avoid the risk and on the correct use of the personal protective equipment required by and made compulsory by the Manufacturer.

residual risk	description procedure-related information
Risk of burns 	When the stove is running, it may reach high temperatures to the touch, especially on its external surfaces. Take care to avoid burns and use the specific tools if necessary. Use the supplied glove to open pellet cover for loading operations.

DESCRIPTION OF THE STOVE

Intended use

The appliance in question is intended for:

operation	allowed fuel	forbidden	setting
Domestic space heating by burning:	pellet	Any fuel other than the permitted ones.	Residential or Commercial

The stove is designed and built to work safely if:

- it is installed by qualified staff according to the specific standards;
- it is used within the limits declared in the contract and herein;
- the operating manual procedures are followed;
- routine maintenance is carried out according to the times and methods set forth;
- extraordinary maintenance is promptly carried out when needed;
- safety devices are not removed and/or bypassed.

 This stove must be intended for the use it was specifically designed for.

Reasonably foreseeable incorrect use

Reasonably foreseeable incorrect use is listed below:

- using the stove as an incinerator;
- using the stove with fuel other than pellet;
- using the stove with liquid fuels;
- using the stove with the door open and the ash drawer out.

Any use of the appliance other than intended must be preventively authorised in writing by the Manufacturer. Without said written authorisation, the use is considered “improper”. Any contractual and non-contractual liability of the manufacturer is excluded for damages to persons, animals or property due to installation and maintenance adjustment errors and improper use.

Obligations and forbidden actions

Obligations

The user must:

- read this instructions manual before performing any operation on the stove;
- the appliance must not be used by children under the age of 8 or by people with reduced physical, sensorial or mental capacities or without experience or without the necessary knowledge, and always with supervision;
- do not use the stove improperly, i.e. for uses other than those described in the “INTENDED USE” paragraph;
- it is strictly forbidden to use liquid fuels;
- keep objects that are not heat and/or flame-resistant at a safe distance;
- only and exclusively load the stove with pellet with the characteristics described herein;
- connect the stove to a regulation chimney;
- provide a suitable system for the supply of combustion air (air intake or intake duct for watertight stoves);
- always perform maintenance with the stove off and cold;
- perform cleaning activities at the frequency stated herein;
- use original parts recommended by the Manufacturer.

Forbidden actions

The user must never:

- remove or change the safety devices without authorisation;
 - perform operations or manoeuvres of his/her own initiative that are not part of his/her job description, meaning that he/she might jeopardise his/her own safety and that of others;
 - use fuels other than pellet and those allowed for lighting;
 - use the stove as an incinerator;
 - use flammable or explosive substances near the stove during operation;
 - use the stove with the door open and/or with the glass ruined or broken;
 - close the combustion air and smoke outlet openings, whatsoever;
 - use the stove to dry laundry;
 - replace or change some of the stove parts.
-
-

Characteristics of the fuel

Wood pellet is a fuel made of pressed wood sawdust, often recovered from processing scraps of carpentries. The material used cannot contain any extraneous substance such as, for example, glue, lacquer or synthetic substances.

The sawdust, once it has been dried and cleaned from impurities, is pressed using a die with holes: as a result of high pressure, the sawdust heats up by activating the natural wood binders; this way the pellet maintains its shape even without adding artificial substances.

Wood pellet density varies based on the type of wood and can exceed that of natural wood by 1.5 - 2 times.

The cylinders have a diameter of 6 mm and a variable length between 10 and 40 mm.

Their density is equal to approximately 650 kg/m³. Due to their low water content (< 10%) they have a high energy content.

The UNI EN ISO 17225-2:2014 standard (that replaces the EN PLUS standard) defines pellet quality by specifying three classes: A1, A2 and B. Maintain fuels and other flammables at a suitable distance.

Ravelli recommends using wood pellet classified A1 and A2 according to the EN ISO 17225-2:2014 standard, or certified DIN PLUS (more restrictive than the A1 class) or ONORM M 7135. Pellet may be light or dark coloured, it is normally bagged into bags that show the name of the producer, the main characteristics and classification according to standards.



Pellets must be transported and stored in a dry area. Upon contact with humidity they swell and become unusable



It is therefore necessary to protect them from humidity, both during transport and during storage.

Non-permitted fuels

We recommend not using the following materials as fuel:

- wood
- treated wood (painted, lacquered, glued wood etc.);
- sawdust or chips
- liquid fuel
- coal or other fossil fuels
- plastic and derivatives
- treated paper and cardboard
- waste
- fuels that release toxic or polluting substances

Using these fuels, on top of being forbidden due to the emission of polluting and harmful substances, causes the stove to deteriorate more rapidly and debris to accumulate in the stove and in the smoke evacuation system, thereby reducing performance and safety.



The gases produced by these fuels are dangerous for the environment and for your health!



Using fuel that is not compliant with the above will void the warranty.

TECHNICAL CHARACTERISTICS

	U	Sphere V	Sphere C
Energy efficiency class	--	A+	A+
Heating input reduced - nominal	kW	5,3 - 12,1	5,3 - 12,1
Heating output reduced - nominal	kW	4,9 - 10,8	4,9 - 10,8
Red. - Nom. Yield	%	91,8 - 89,0	91,8 - 89,0
Hourly consumption	kg/h	1,09 - 2,50	1,09 - 2,50
Loading interval	h	11 - 26	11 - 26
Max. heating volume*	m ³	255 - 305	255 - 305
CO at 13% of O ₂	%	0,020 - 0,002	0,020 - 0,002
	mg/m ³	248 - 29	248 - 29
OGC at 13% of O ₂	mg/m ³	9 - 1	9 - 1
NO _x at 13% of O ₂	mg/m ³	126 - 146	126 - 146
PM at 13% of O ₂	mg/m ³	9 - 14	9 - 14
Smoke temperature	°C	105 - 188	105 - 188
Smoke flow	g/s	4,8 - 7,4	4,8 - 7,4
Minimum draft	Pa - mbar	10 - 0,1	10 - 0,1
Electrical connection	Hz - V	230 - 50	230 - 50
Electrical power consumption max.	W	250	250
Electrical power consumption reduced - nominal	W	57 - 93	61 - 100
Stand-by electrical consumption	W	2	2
smoke air inlet Ø	mm	50	50
smoke outlet pipe Ø	mm	80	80
Hopper capacity	kg	28	28
Seasonal energy efficiency	%	85,5	85,3
Type of room temperature control	with electronic room temperature control plus week timer		
Other control options	with distance control option		

The data shown here is provided as a guideline and is not binding, and may change based on what type and quality of wood is used. Ravelli reserves the right to make any changes in order to improve product performance.

* Heatable volume based on the requested power equal to 35 W/m³ and 55 W/m³

Minimum clearances from combustible materials	
	Sphere V - Sphere C
R Right side	200 mm
L Left side	200 mm
B Rear	100 mm
A Front	800 mm

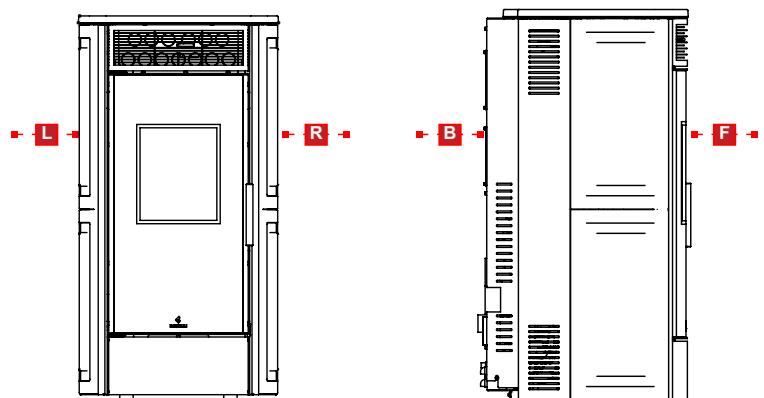

It is recommended to leave a space of 50 cm on at least one side for maintenance operations.

Measurements

	Unit of measurement	Sphere V Déco	Sphere C Déco	Sphere V Steel	Sphere C Steel
Height	mm	1145	1145	1145	1145
Width	mm	597	597	597	597
Depth	mm	599	599	599	599
Weight	kg	190	200	180	190

Technical diagram Sphere V Déco e Sphere V Steel

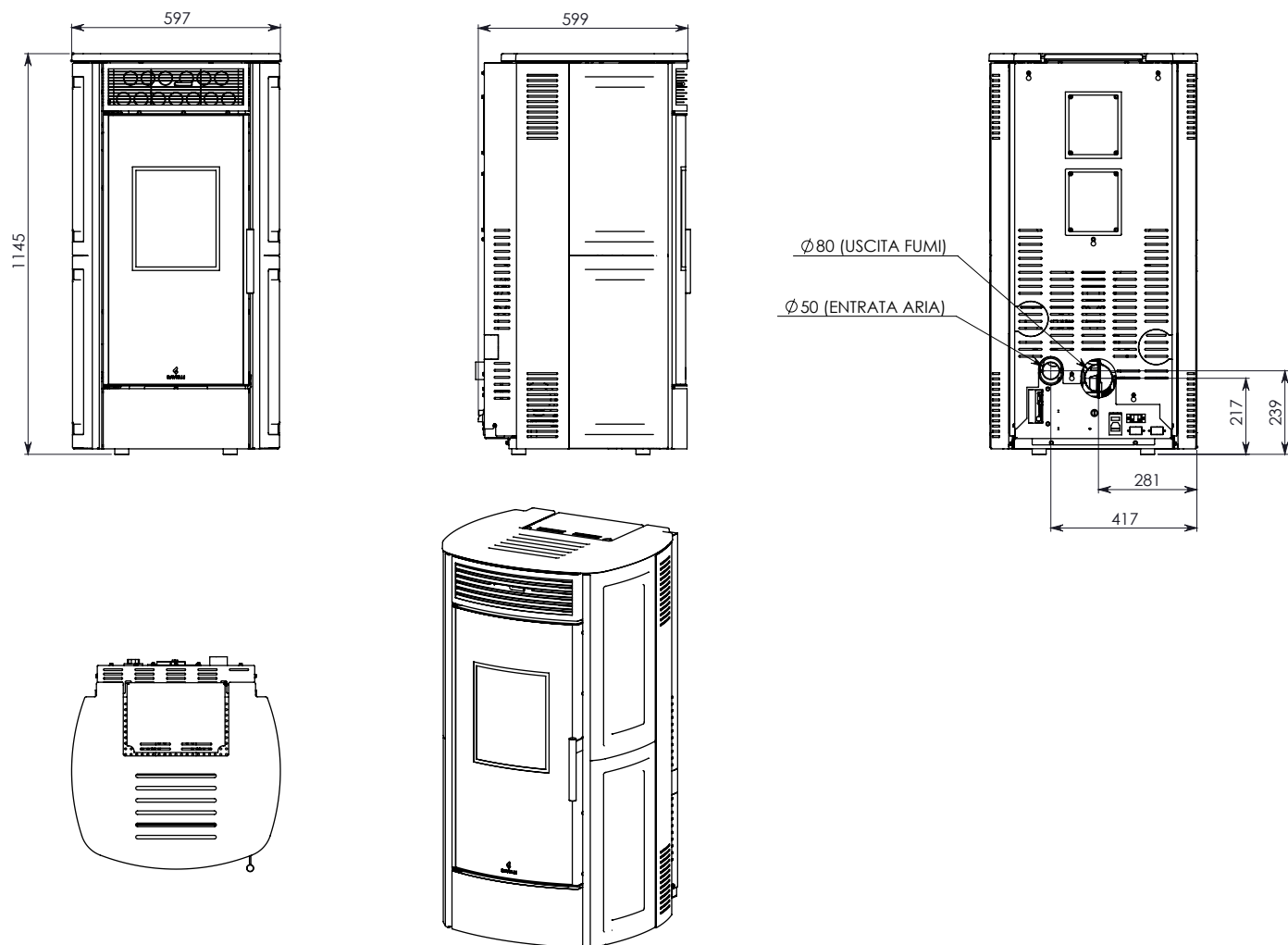

Technical diagram Sphere C Déco e Sphere C Steel

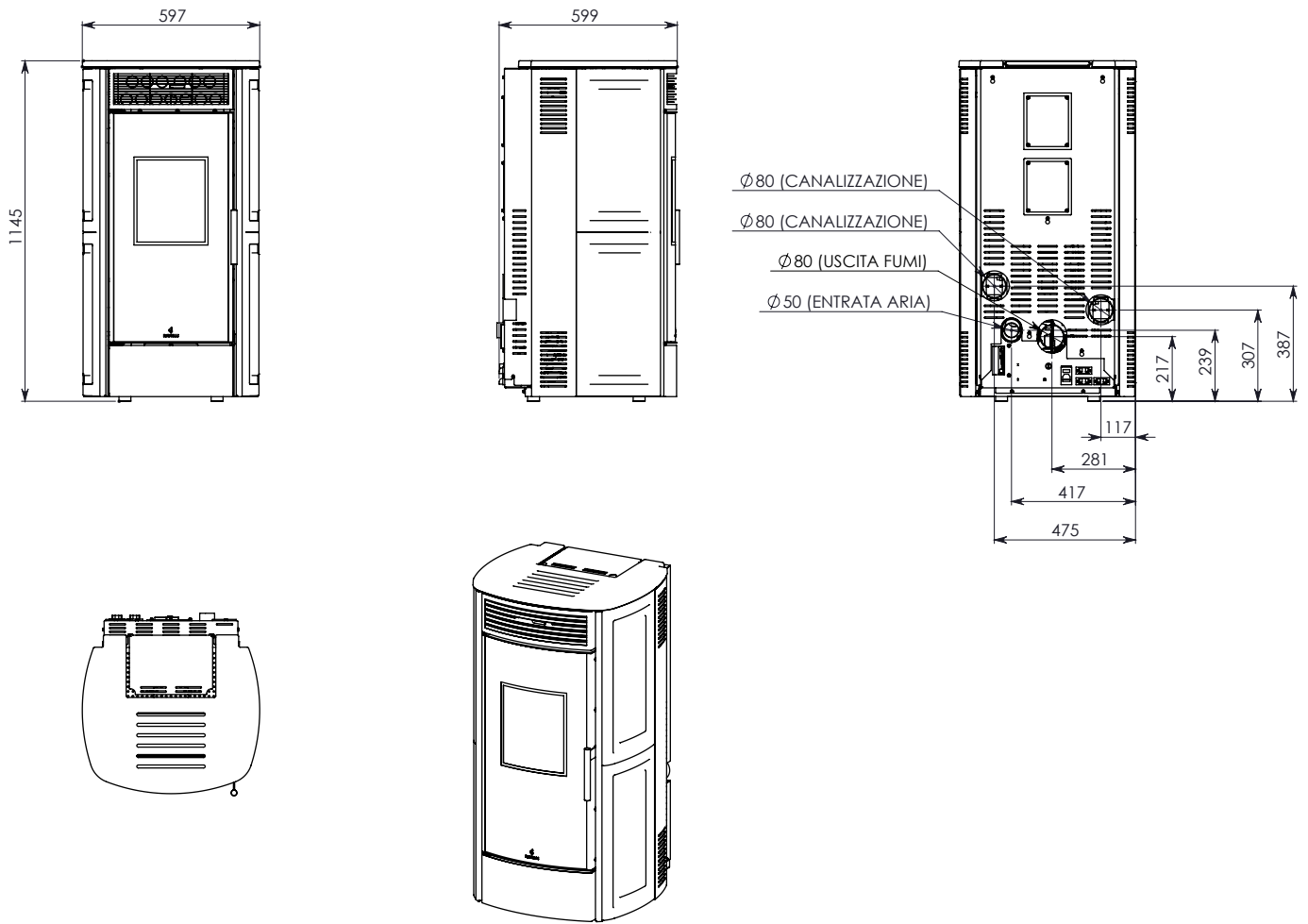

Main parts

element			
A	Grid for air passage	E	Control panel
B	Combustion chamber door	F	Combustion chamber
C	Ashes drawer	G	Grid for ashes
D	Pellet cover	H	Brazier

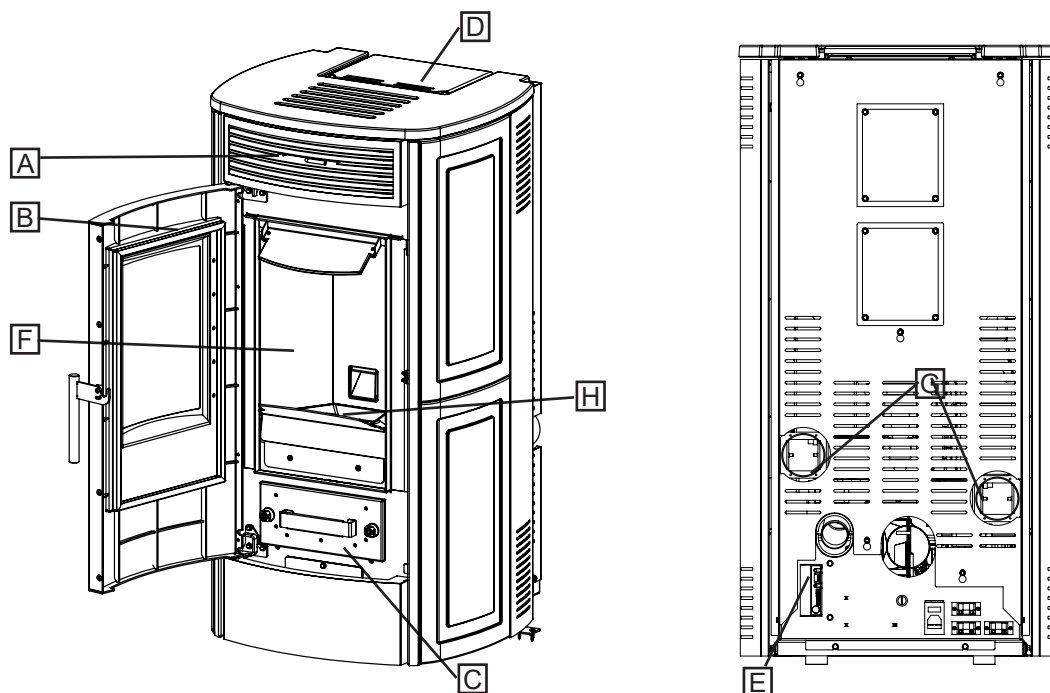

Description of operation

Ravelli Sphere pellet stoves are appliances for domestic heating powered by wood pellets with automatic loading. They are suitable for use as a secondary heating system or as a support for the main heating system.

The heat generated by pellet combustion is diffused in the installation room thanks to the ventilation system as well as natural radiation and convection. Two other rooms can be heated in the ducted versions.

The stove is controlled by an electronic control unit that manages the start-up, operation and shutdown phases and also includes many other functions for control, programming and safety.

The user can choose the operating power from 5 levels, or set the temperature to be maintained in the rooms. In this case the stove will manage the power to ensure maximum comfort. Among the functions of the electronic control unit there is also that of being able to program the stove's start-up and shutdown by setting the weekly chronothermostat.

All this can be done comfortably from the sofa using the handheld remote control.

FUNCTION	DESCRIPTION
Hermeticity	50 Pa Acc. EN613
Ventilation (V version)	Automatic
Ventilation (C version)	Adjustable from 1 to 5 Automatic
Ducting (C version)	Double ducting Manual or automatic (RFS)
Fire pot	With automatic cleaning system
Chronothermostat	Weekly - 4 programs
RDS system	Not available
Thermal reset	Manual

Automatic cleaning system

The stove is equipped with automatic brazier cleaning system. This means that there is no need to carry out daily manual cleaning of the brazier or every time the stove is lit. The automatic cleaning system is activated every time the stove is lit and after 6 hours of continuous operation. The cleaning cycle, which involves shutting down, automatic cleaning and restarting the stove, takes about 10 minutes. During this period the heating is guaranteed by the heat accumulated by the appliance itself.

Note: the times indicated are those set by default by the Manufacturer.

Recharge the fuel



Use only wood pellets, the characteristics shown in this manual.



During pellet loading prevent the pellet bag from coming into contact with hot surfaces.



It is not recommended to empty the pellet bag directly into the hopper to avoid depositing wood sawdust on the bottom of the hopper.

To load the pellets inside the hopper, proceed as described below:

	step
1	Open the pellet hopper cover
2	Pour the pellets into the hopper
3	Close the pellet hopper cover

Doors opening

The combustion chamber door, the pellet hopper lid and the ash drawer can only be opened when the stove is in the OFF state. If one of them is not closed, the pellet supply is interrupted, the control unit emits an acoustic warning signal, while the symbol appears on the display:



In this condition, by touching the CONFIRM button you can read the detail of the warning: "doors and ash pan open". If the combustion chamber door, the pellet hopper lid and / or the ash drawer are not closed within 1 minute, the stove switches off signaling ALARM 07. Opening the doors also interrupts the automatic cleaning phase of the brazier. In the event of a prolonged interruption of the cleaning phase, ALARM 19 may appear.

Remember that in the presence of an alarm the stove will have to be restarted manually.

User training

Once installation is complete, the user must always be fully trained in the functions and characteristics of the stove by the technician authorized by Ravelli to ensure optimal and safe use.

The training should cover the following topics:

- Description of the stove, its operation and basic settings
- How to turn the stove on and off safely
- Fuel storage and refilling
- What to do in the event of an alarm, in particular that of "no ignition"
- How to clean the stove correctly and the importance of performing it on a regular basis
- It is advisable to schedule the first annual maintenance

Safety devices

The stove has been designed and equipped with safety systems to minimize user risks.

It is equipped with the safety devices listed in the following table, which also intervene in case of failure of the electronic board.

Element	Description
Pellet tank thermostat	If the temperature exceeds the set safety value, it immediately stops the pellet loading motor and the stove is automatically switched off; to restart it, it is necessary to wait until it has cooled down and manually reset the thermostat, using the appropriate button.
Pressure switch	If the pressure in the smoke outlet duct is too high (a sign that the smoke evacuation system is obstructed) it immediately stops the pellet loading motor and the stove switches off automatically.
Combustion chamber door closing limit switch and pellet hopper lid	If the door of the combustion chamber and pellet hopper lid are not properly closed, they immediately stop the pellet loading motor; if they are not closed within 60 seconds, the stove switches off automatically.
Electrical safety	In case of failure of the electrical components or wiring, the fuse and grounding keep the appliance safe. It is necessary that the electrical system of the house is up to standard, equipped with a grounding circuit and all the safety systems required by the standards.

It should be noted that the stove's operating program has been designed to stop stove operation in the event of malfunctions:

Anomalies	Description
Temperature in the combustion chamber	If the temperature probe in the combustion chamber detects temperatures that are too high or too low, the stove is switched off and the relative alarm is displayed.
Flue gas temperature	If the temperature probe at the smoke outlet detects temperatures that are too high, the stove is switched off and the relative alarm is displayed.
Smoke fan break	If the fan stops, the electronic board blocks the supply of pellets and the alarm is displayed.
Gear motor failure	If the gear motor stops, the appliance switches off safely.
Temporary power failure	If a power failure occurs during operation, when the power returns the temperature in the combustion chamber is checked and, if necessary, the stove goes into cooling mode.
No ignition	If no flame develops during the ignition phase, the stove goes into alarm.



It is forbidden to tamper with the safety devices. Restarting the product is only possible after eliminating the cause that caused the intervention of the safety system. To understand which anomaly occurs, consult this manual which explains, depending on the alarm message that the device displays, how to intervene on it.



If the problem persists, contact the Support Service.

The Majolica cladding (if applicable)

The Majolica cladding is artisan-crafted and hand-finished.

For this reason there may be minor imperfections on the surface such as slight discoloration and hair cracks, which are considered characteristics that make each Majolica a unique piece.



Since the Majolica cladding is made with a delicate material, we recommend handling it with care during cleaning and avoiding sudden impact that may cause damage.

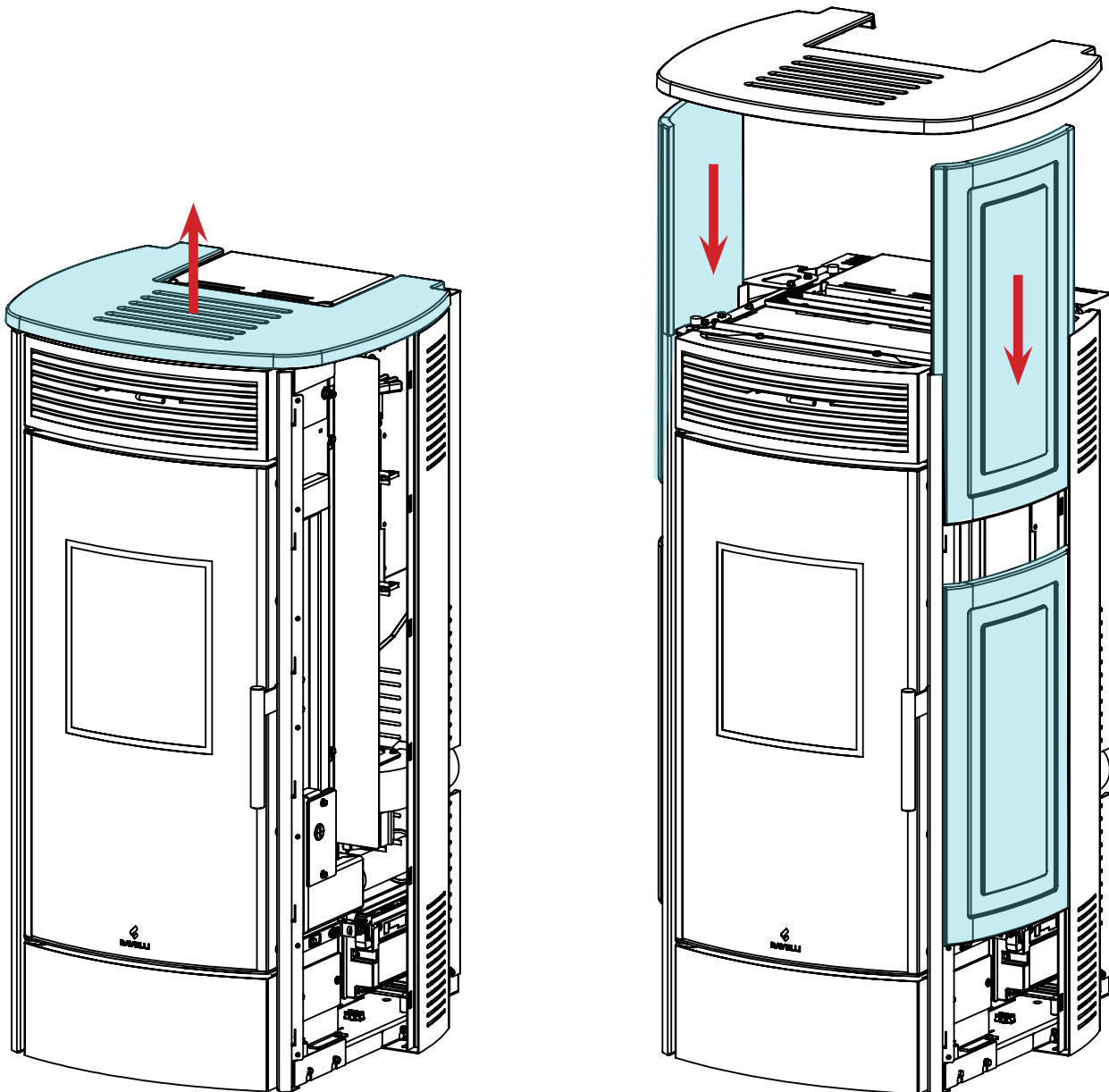

SHIPPING AND INSTALLATION

Safety warnings for transportation and installation



The stove must be installed by a qualified technician, who must issue a declaration of conformity of the system to the purchaser, taking full responsibility for stove installation and correct operation.



The stove installation site must be chosen so that the generated heat can spread evenly throughout the rooms that you wish to heat.



The stove needs to be connected to a single chimney that guarantees the draught declared by the Manufacturer and observes the installation regulations that apply to the installation site.



The room where the stove is installed must have an air intake.



The air vent must be installed in such a way that it can not be blocked.

The Manufacturer will not be held liable for installation that is not compliant with the laws in force, incorrect air circulation in the rooms and inappropriate use of the appliance.

In particular, it is necessary:

- that the appliance be connected to a smoke evacuation system duly sized to guarantee the draught declared by the Manufacturer, that is tight and observes the distances from flammable materials;
- that there is a suitable combustion air intake in compliance with the type of installed product;
- that other installed combustion appliances or devices do not create a vacuum in the room where the stove is installed;
- that the safety distances from flammable materials are observed.

Verification of system compatibility has a priority over any other assembly or installation operation.



Local administrative regulations and particular requirements of the authorities pertaining to the installation of combustion appliances, the air intake and the smoke evacuation system, may vary based on region or nation. Check with your local authorities if there are stricter laws than set forth herein.

Packaging

When the stove arrives, check:

- that it is the model you ordered;
- that it has not been damaged during shipping.

Any complaints must be reported to the deliveryman (also on the delivery note) upon receipt.



Check the capacity of the floor before handling and positioning the stove.

To handle the stove in its packaging, follow the procedure below:

- 1 Position the pallet truck forks in the slots under the wooden pallet.
- 2 Lift slowly.
- 3 Place the stove near the chosen location for installation.



The stove always needs to be handled vertically. Take extra care to protect the door and its glass against mechanical impact that could jeopardise their integrity

To unpack the stove, follow the procedure described below:

- 1 Cut the straps and remove the wooden reinforcement frame resting on the box
- 2 Slowly lift the cardboard box
- 3 Remove any bubble-wrap or similar
- 4 Remove the stove from the pallet and position the appliance in the chosen location, ensuring that it is compliant with the directions.

If the stove is packed in a wooden cage, replace steps 1 and 2 of the previous table with the steps described below:

- 1 Remove the side straps by unscrewing the fixing screws
- 2 Remove the upper and side wooden cage



The end user is responsible for disposing of the packaging in accordance with the laws in force in the country of installation.

Set-ups for the smoke evacuation system



Be careful when building the smoke evacuation system and observe the regulations in force in the country where the stove is installed.



The Manufacturer will not be held liable for incorrectly sized and non-regulation smoke evacuation systems.

Smoke ducts and fittings

The term smoke duct indicates all ducts that connect the combustion equipment to the chimney.

The following requirements need to be applied:

- observe product standard EN 1856-2;
- the horizontal sections must have a minimum slope of 3% upwards;
- the length of the horizontal section must be as minimum as possible, and its projection on the horizontal plane must not exceed 2 metres;
- changes in direction must not have an angle of more than 90° (45° bends are recommended);
- the number of direction changes, including the one necessary for insertion into the chimney, must not exceed 3;
- the cross section must have a constant diameter, the same from where it exits the firebox up to the fitting into the chimney;
- it is forbidden to use flexible metal and fibre cement pipes;
- smoke ducts must not cross rooms where the installation of combustion equipment is prohibited.

In any case, the smoke ducts must be sealed against combustion products and condensation, as well as insulated if they lead outside of the installation room.

Installing manual draught adjustment devices is not allowed.

Chimney

The chimney is a particularly important element for correct stove operation.



The chimney must be sized so as to guarantee the draught declared by the Manufacturer.



Do not connect the stove to a collective chimney.

The chimney must be built applying the following regulations:

- it must observe product standard EN 1856-1;
- it must be made of materials that are suitable to guarantee resistance against normal mechanical, chemical and thermal stress and be correctly thermally insulated to limit the formation of condensation;
- it must be mainly vertical and not feature any bottlenecks along its entire length;
- it must be correctly spaced with an air gap and insulated from flammable materials;
- there must be a maximum of 2 changes in direction and angles must not exceed 45°;
- the chimney inside the home, however, must be insulated and can be inserted into a skylight shaft, as long as it respects standards regarding placing inside a tube;
- the smoke conduit must be connected to the chimney using a "T" fitting with an inspection collection chamber for combustion residue and especially for collecting condensation.



It is necessary to check the safety distances that need to be observed when there are flammable materials and the type of insulating material that needs to be used is on the chimney data plate.



Use watertight pipes with silicone seals.



It is forbidden to use the discharge mounted directly on the wall or directed towards indoor spaces and any other type of discharge that is not set forth by the regulation in force in the country of installation (Note: in Italy only roof-discharge is allowed).

Chimney pot

The chimney pot, i.e. the top end of the chimney, must fulfil the following characteristics:

- the cross-section of the smoke outlet must be at least twice the internal cross-section of the chimney;
- it must stop water or snow from getting in;
- make sure the smoke is taken away even when there is wind (wind resistant chimney pot);
- the outlet height must be outside of the reflux zone (refer to national and local regulations to calculate the reflux zone);
- it must always be built at a distance from antennas or dishes, it must never be used as support.

Installation

 For appliance installation and use it is necessary to observe all of the local, national and European laws and regulations.

 Stove installation and the preparation of the building work must observe the regulation in force in the country of installation (ITALY = UNI 10683).

 The installation activities must be carried out by a technician that is qualified and/or authorised by the Manufacturer. The staff in charge of installation must issue a declaration of conformity of the system to the buyer, whereby they take full responsibility for the final installation and good operation of the installed product.

 Ravelli shall not be held liable if these precautions are not followed.

Requirements for the installation premises

The stove installation room must be sufficiently ventilated. To fulfil this requisite it is necessary to equip the room with an air intake connected to the outdoors.

 The installation room must have an air intake with a free cross-section of at least 80 cm².

 For installation in the presence of other combustion appliances or VMC system it is necessary to check the appliance for correct operation.

The stove must be placed inside living quarters. It must never be installed outdoors. The volume of the room where it is installed must be suitable for the power of the appliance and, in any case, greater than 15 m³.

 When extraction fans (example: extraction hoods) are used in the same room or space as the stove, this can cause problems to stove operation.

 The stove must be installed on a floor with suitable load capacity. If the existing position does not fulfil this requirement, it is necessary to take due measures (for example, using a load distribution plate).

 Provide due insulation if the surface is made of flammable material.

If the side walls adjacent to the stove are made of a flammable material, it will be necessary to position the stove at least 30 cm from them.

If the floor that the stove is standing on is flammable, we recommend duly insulating it. Objects and parts that are heat-sensitive or flammable cannot be stored near the stove; in any case, keep such objects outside the area bounded by the minimum distances indicated above.

Stove installation must guarantee easy access to clean the appliance, the exhaust ducts and the chimney.

Installation example for a stove/pellet stove

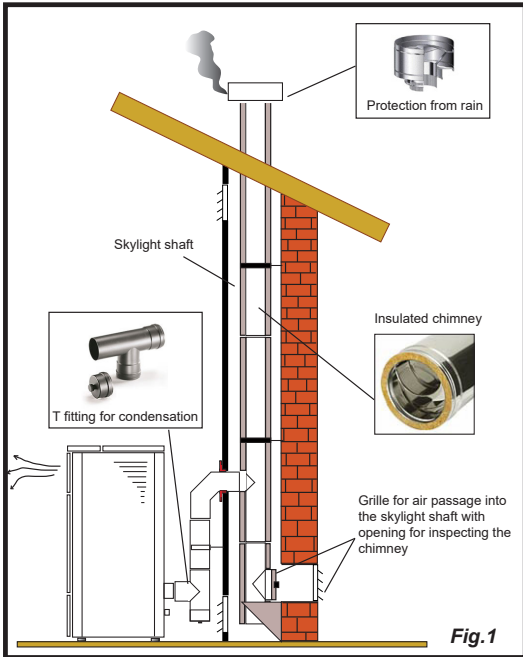

This type of installation (See Fig.1) requires an insulated chimney pot, even if the entire conduit is installed inside the building. Besides, the structure must be inserted into a properly ventilated skylight shaft.

In the lower part of the chimney pot there is an inspection cover, properly isolated from wind and rain.

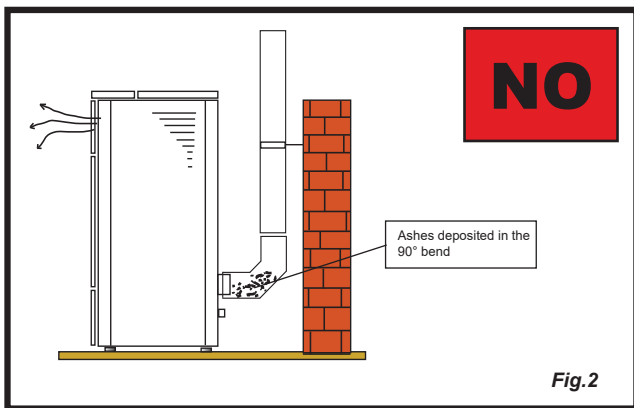

It is prohibited to install a 90° bend for the initial segment, since the ashes would quickly obstruct smoke passage, causing draught problems in the stove. (See Fig. 2)

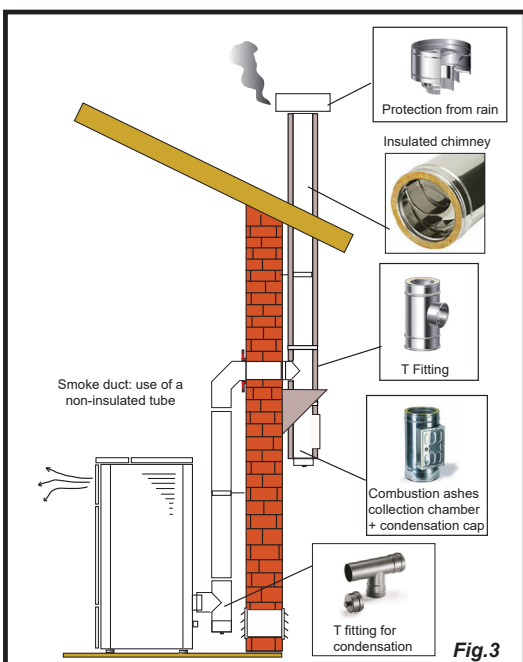

It is possible to use an existing chimney or a shaft via ducting. For this type of installation the standards on ducted smoke evacuation systems must be complied with. In the lower part of the chimney pot, inside the home, there is a "T" type fitting installed; externally there is another one installed, so that the outside section can be inspected.

It is prohibited to install two 90° bend, since the ashes would quickly obstruct smoke passage, causing draught problems in the stove. (See Fig. 2)

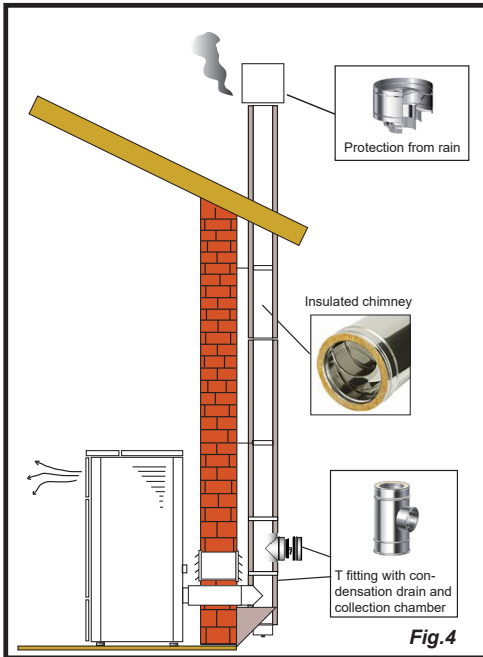

This type of installation (See Fig.4) requires an insulated chimney pot, even if the entire smoke conduit is installed outside the building.

In the lower part of the chimney there is a "T" type fitting installed with inspection cap.

It is prohibited to install a 90° bend for the initial segment, since the ashes would quickly obstruct smoke passage, causing draught problems in the stove. (See Fig.2)

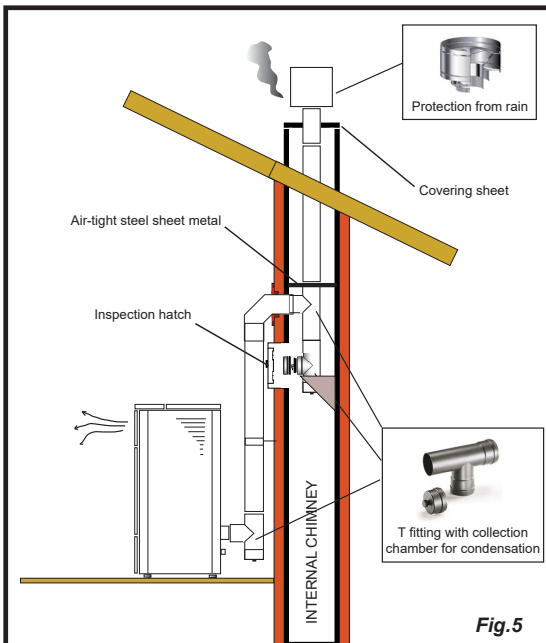

This type of installation (See Fig.5) requires an insulated chimney pot, since the entire smoke conduit is installed inside the building, and the part is located inside a pre-existing chimney pot.

In the lower part of the stove there is a "T" type fitting installed with inspection cap just like for the chimney pot.

It is prohibited to install a 90° bend for the initial segment, since the ashes would quickly obstruct smoke passage, causing draught problems in the stove. (See Fig.2)

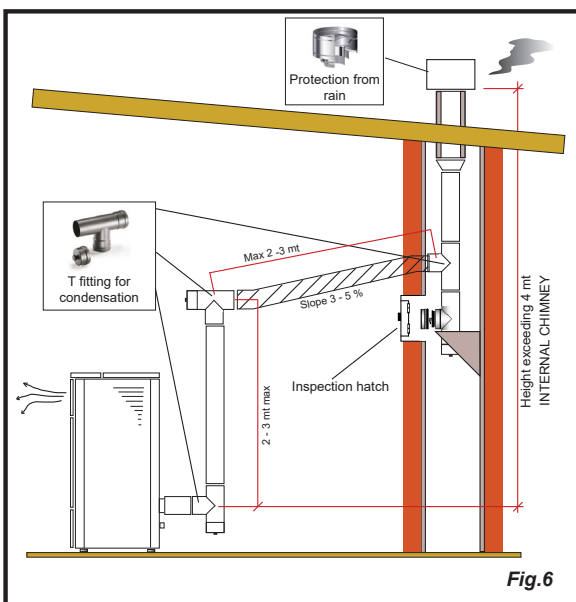

This type of installation (See Fig.6) requires a horizontal section to connect to a pre-existing chimney pot.

Respect the slope indicated in figure, in order to reduce the ashes depositing in the horizontal tube. In the lower part of the chimney pot, there is a "T" type fitting installed with inspection cap, in the same way as the chimney pot opening.

It is prohibited to install a 90° bend for the initial segment, since the ashes would quickly obstruct smoke passage, causing draught problems in the stove. (See Fig.2)

CONNECTIONS



The connections must be set up by a technician that is qualified and/or authorised by the Manufacturer.



By the installer the type of cable, with relative section, to be installed in case of replacement is: H05RR-F sez.3G0,75

Connection with external air intake

The stove has been designed for hermetic installations.

To make the connection with an external air intake, proceed as follows:

step	action
1	Connect a 50 mm diameter pipe to the combustion air inlet pipe at the back of the stove. Note: the pipe must be no more than 2 m in length.



The air vent must be installed in such a way that it can not be blocked.

Chimney connection



The chimney must be sized so as to guarantee the draught declared by the Manufacturer.



The stove must be connected to a single flue. It is forbidden to connect the stove to a flue shared with other combustion appliances or with hood exhausts.



The flue must be inspectable for cleaning.

Electrical connection

The plug of the stove's power cable must only be connected after the installation and assembly has been completed of the appliance, and must remain accessible after installation.

To make the electrical connection, proceed as described below:

First connect the power cable to the plug on the back of the stove and then to a wall socket.

Supply power to the stove by turning the switch to position (I).



When the stove is not in use, it is advisable to disconnect the power cable.



Take care that the power cord (and any other cables outside the equipment) do not come into contact with hot surfaces.



Ensure that the electrical system is grounded.



For direct connection to the mains, it is necessary to provide a device that ensures disconnection from the mains, with a contact opening distance that allows complete disconnection under the conditions of overvoltage category III, in accordance with installation rules



If the power supply cable is damaged, it must be replaced by the manufacturer or its technical assistance service or in any case by a person with similar qualifications, so as to prevent any risk.



It is recommended that authorized personnel pay special attention to the electrical connections after any work on the product.

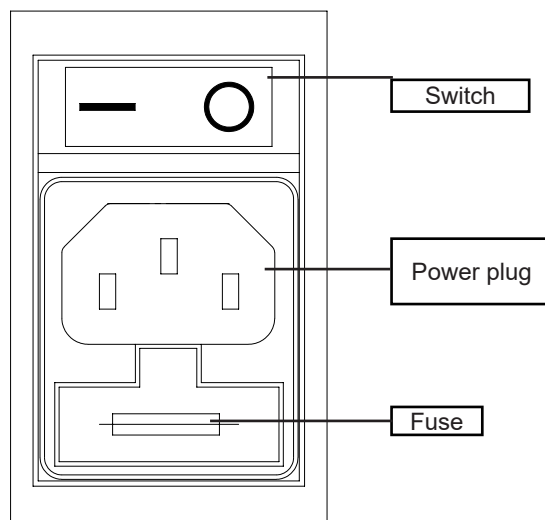

Ducting



Comply with the standards and laws in force in the region where the product is installed.

Connect a 80 mm diameter pipe to the stove outlet of the ducting to heat another room of the home. The size of the duct (length and shape) must take into consideration the residual head of the fan of the ducting shown here.



Use pipe and gaskets capable of withstanding high temperatures (which can even reach 200°C): it is recommended to use metal pipes and silicone gaskets.

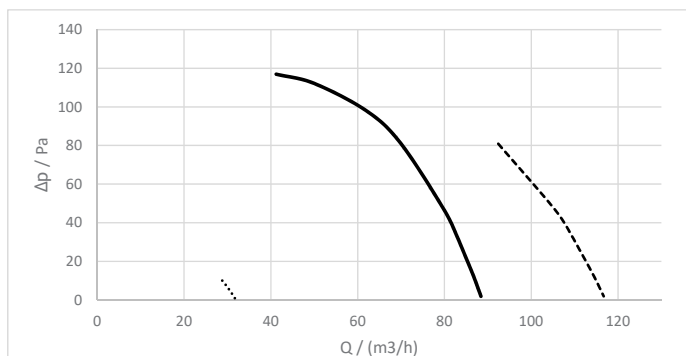

D: portata

Δp: prevalenza

— egualmente ripartito

--- sbilanciamento massimo



The ducting pipe can reach very high temperatures: it must therefore be appropriately insulated with adequate materials, at the points which can come into contact with flammable surfaces or are sensitive to high temperatures in addition to protecting people and pets from possible burns.



If a rigid pipe is used for channelling, it is recommended to use 45° bends.

When crossing through walls built with flammable materials, these materials must be protected by using insulating materials or taking appropriate measures.

It is recommended to insulate the entire length of the ducting pipe to avoid heat dispersion.



It is compulsory to connect the stove to the duct of the house before lighting. Make sure that it is not possible to touch the fan blades, installing the necessary safety measures (e.g.: duct grille or pipe longer than 620 mm).

The duct withdraws much air from the room where the stove is installed, releasing it in another room to be heated. This is why it is recommended to guarantee air circulation between the room where the stove is installed and the environment heated by the duct. This allows for ideal heating of the rooms keeping outdoor cold air from coming back in and preventing heat loss.

See the specific chapter to learn the ducting settings.

Connection of external probe or thermostat

To manage the ducting in automatic mode, connect a temperature probe (optional) or external thermostat (optional) to the "REAR" connector.



Connect an open/closed external thermostat, therefore potential-free.

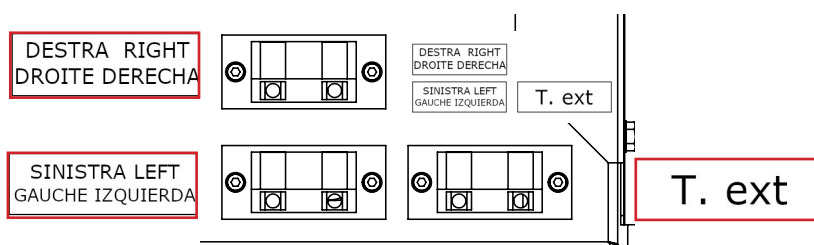

Testing and commissioning

Stove start-up must be preceded by testing, which includes an operational check of the following elements:

- connection to the smoke evacuation system;
 - electrical connections;
 - operation of any connected external probes;
 - checking that all materials used to build the smoke duct, chimney and chimney pot are regulation and suitable for use.
- The testing is positive only when all operational phases have been completed without any anomaly being detected.

Electric scheme Sphere C Déco e Sphere C Steel

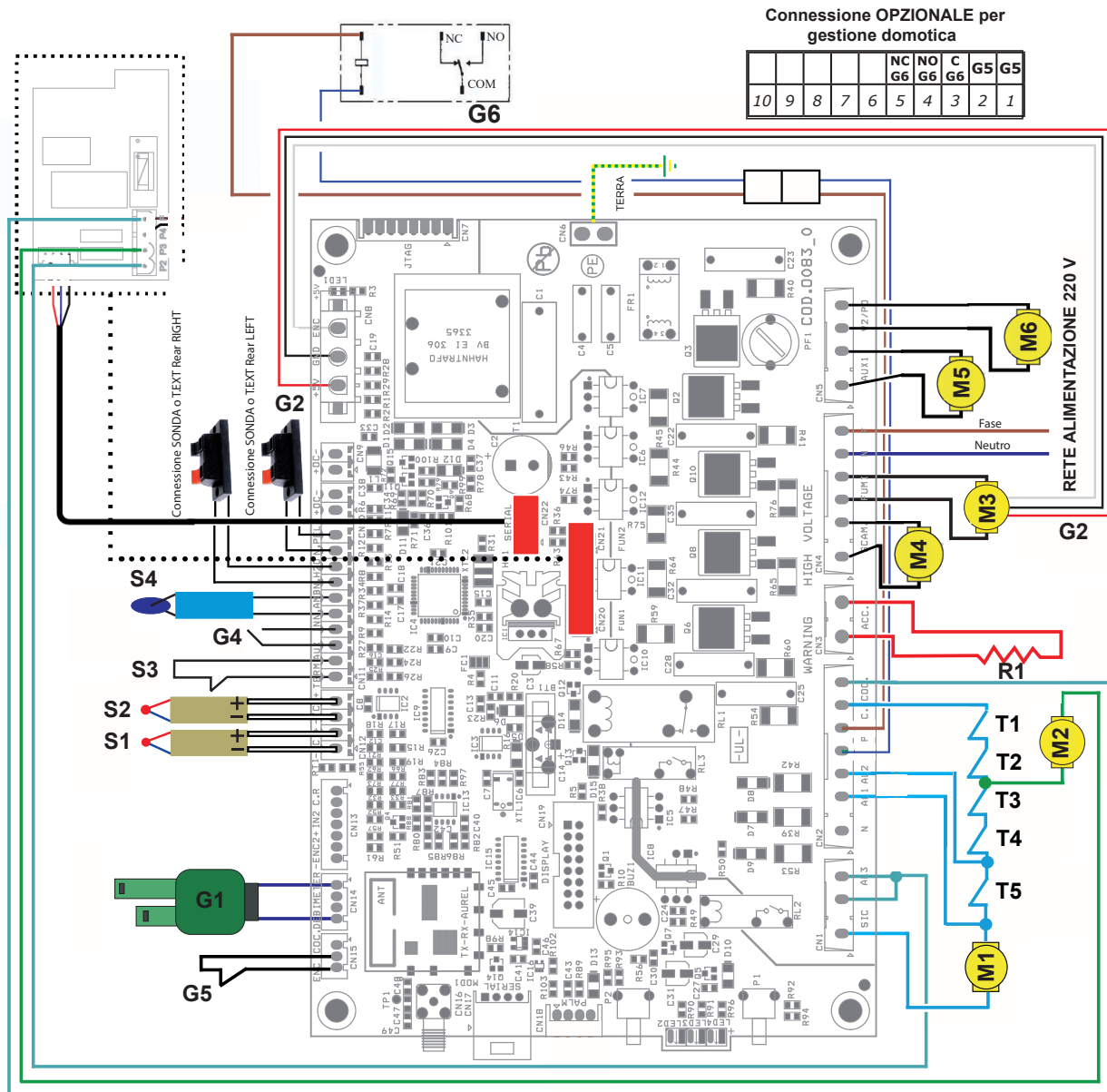

LEGEND

Safeties

- T1 - Fire door contact
- T2 - Ash drawer contact (if applicable)
- T3 - Pellet hopper contact
- T4 - Pellet thermal safety
- T5 - Pressure switch

Motors

- M1 - Auger gear motor
- M2 - Automatic cleaner
- M3 - Flue gas fan
- M4 - Frontal Heat exchanger
- M5 - Right Heat exchanger
- M6 - Left Heat exchanger

Resistance

- R1 - Igniter

Probes

- S1 - Flue gas probe (J)
- S2 - Flame probe (K)
- S3 - External thermostat
- S4 - Room probe (opt)

Generic

- G1 - Air-flow meter
- G2 - Encoder for reading extractor rpm
- G3 - RADIO Touch handheld remote control
- G4 - Automatic cleaner stroke counter
- G5 - Home automation management contact
- G6 - GAS ignition contact - Home automation output alarm signalling (TRF 39)

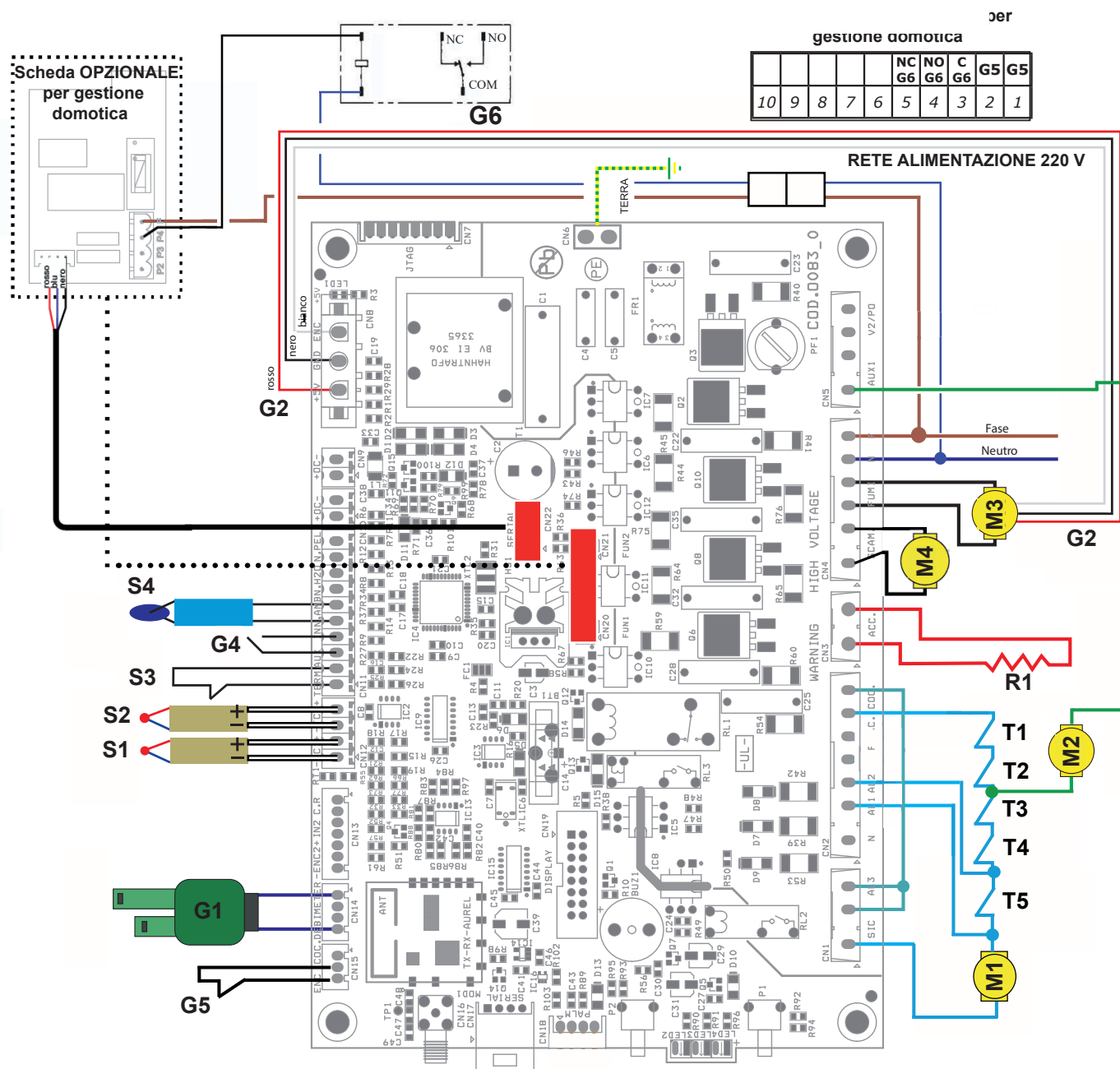

Electric scheme Sphere V Déco e Sphere V Steel

CONTROLS AND USE

Control panel description

The stove is controlled by an electronic card that allows fully automatic and controlled combustion. It allows to regulate the ignition phase, the power levels and the shutdown phase, guaranteeing safe operation. On the back of the stove there is a control panel that allows you to synchronise the electronic discharge with the handheld computer and turn the stove on/off.

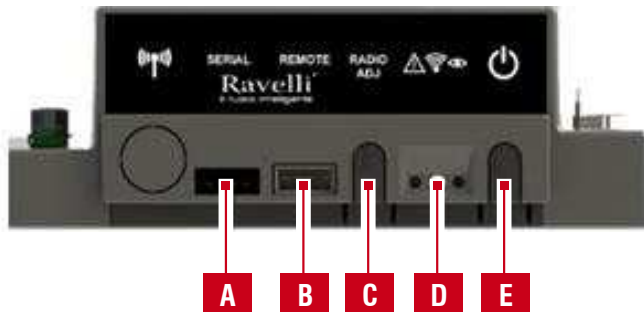

A	Serial socket
B	Handheld cable connection socket
C	ADJ Radio: button to connect the handheld to the card
D	Signaling Led Red: active allergy Yellow: Awaiting communication with the handheld Green: Stove on
E	Stove on/off button

Handheld touch radio initialization

The handheld, after a first short screen showing the Ravelli logo, will list the languages available in the menu. Select the desired language with the scroll buttons and confirm your selection with the confirmation button.



In order to operate correctly, the handheld set should be interfaced with the electronic board installed inside the stove. For this reason, on display appears the following message:



If the handheld set is used for the first time, select YES using the selection keys and confirm with the dedicated key. On the display of the handheld set appears the following:



The flashing yellow LED indicates that the circuit board is waiting to receive the signal from the handheld set.

By pressing the enter key on the handheld set, the components start communicating with each other. A check sign on the display, accompanied by a sound signal, shows that the initialization of the handheld set has been completed successfully



In case of battery replacement, it is not necessary to perform the initialization procedure of the handheld computer. In this case, when the display will show the message "FIRST INSTALLATION ?", select NO and press the dial key.

Description of the handheld set

The PDA looks like the following picture:

The information below will familiarize you with the product and give you the best performance.

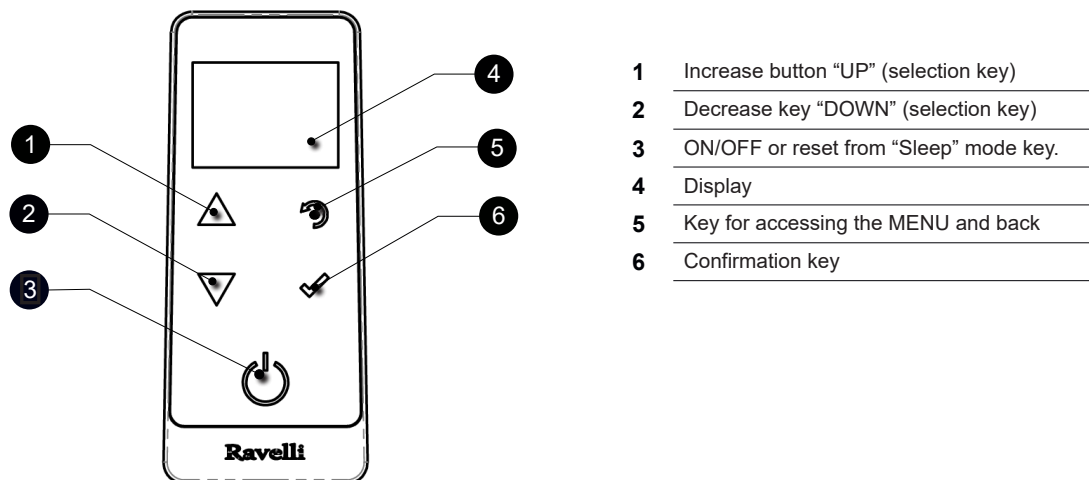

In "Sleep" mode, the handheld computer screen is darkened, but radio communication with the stove is still active in order to reduce battery consumption.

How to insert the batteries in the handheld set:

Remove the protective cover of the battery on the back of the remote control as shown in Figure A, and insert the 3 batteries (mini pen style battery AAA 1.5V) in the housing of the handheld set and observe the poles. Install the battery protective cover as shown in figure B



Figura A



Figura B

What happens if the batteries are empty

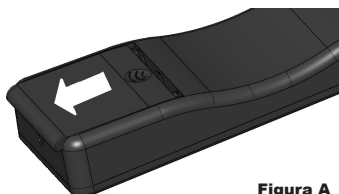
If the battery is discharged, within the "drop" is shown a symbol that indicates that the battery is empty, while maintaining active the features of your device.

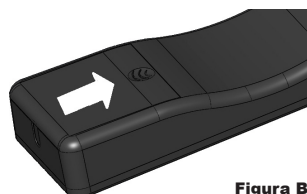

As soon as the level of the battery prevents the radio communication the handheld set displays on full screen the picture of empty battery and all device functions are locked until the batteries are replaced.



If not in use for a long time, we recommend removing the batteries from the remote control.

Description of the display

The display of the handheld set is described below (in "Home" mode):

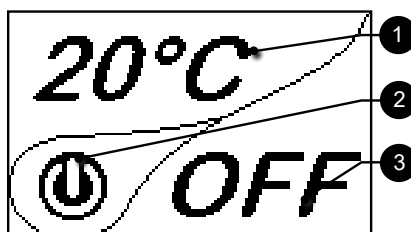



After 5 minutes of inactivity, the handheld display dims to "SLEEP" mode while maintaining the radio connection to the stove. A subsequent press of the ON/OFF key reactivates the display.



The first press of any key with active display turns on its backlight, not interpreting it as a command.

The display is subdivided into three parts:

1- It shows the current room temperature measured by the handheld set. Moreover, if you press the DOWN scroll key you will display the temperature settings that can be changed using the two UP/DOWN keys. Any change made is confirmed automatically within 3 seconds from the change or by pressing the confirmation key. A sound signal indicates that the change has been confirmed.



2- Icon indicating the status of the stove (see synthetic phase diagrams).

3- In the inactive phases (combined with the second part of the display) indicates the state of the stove. In the active phases, it indicates the operating power of the stove. In addition, by pressing the DOWN scroll button, you can display the power settings, that can be edited using the two scroll keys UP/DOWN: The confirmation of any change takes place automatically within 3 seconds from the change or by pressing the confirmation key. A sound signal indicates that the change has been confirmed.



Time and date setting

Below are given the steps for accessing the relative menu

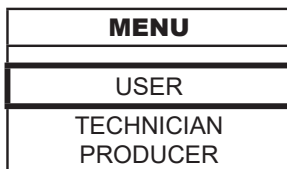

Press the key "access menu" to access the MENU page

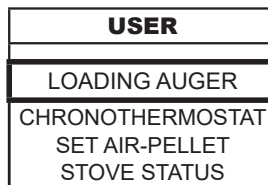

Press the key "confirm" to access the USER page

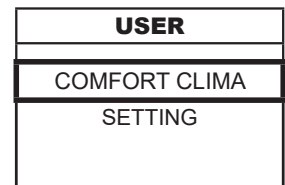

Press the key "selection" for "selection" to switch to the second page of USER MENU and select SETTINGS.

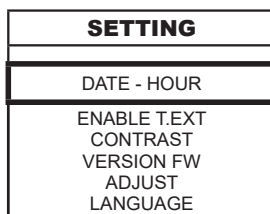

Press the key "confirm" to access the SETTINGS page



Press the key "confirm" to access the page DATE-TIME



Press the increase key to change every single value



Press the decrease key to change every single value



Press "confirm" to confirm the settings and switch to the next value.



By pressing the key "back" for several times you will display the stand-by page.

PROCEDURES FOR USE

 If the chimney catches fire you must call the fire brigade immediately.

Checks prior to start-up

 You have read and perfectly understood the contents of this instructions manual.

Before lighting the stove, you must ensure that:

- the pellet tank is full;
- the combustion chamber is clean;
- the fire door and ash drawer seals are functioning properly;
- the electrical plug is connected correctly;
- all items that could burn (instructions, various adhesive labels) have been removed;
- the brazier, if removable, is correctly positioned in its housing.

 During the first hours of use the paints used for the stove finish may release an unpleasant odour. You might also smell the typical odour of metal parts subject to high temperatures. Make sure sufficient air circulation is guaranteed in the room. These unavoidable inconveniences will disappear after the first hours of operation. To reduce your discomfort to a minimum, keep the stove on for a few hours on low power and in the beginning, do not overload it, avoiding intense heating-cooling cycles

 At the initial start-up, the paint finishes drying and hardens. Accordingly, to avoid ruining it, we advise you not to touch the stove's painted surfaces at this time.

Feed screw loading

Before starting the stove for the first time, whenever the stove is in alarm "06 - Pellets finished", and in any case whenever the hopper has emptied completely, the initial feed screw loading is required. This phase serves to fill the pellet loading system so that, at the time of ignition, the correct pellet loading takes place in the brazier. In the event that the feed screw operations are not carried out, there may be stove ignition failures.

 After loading the auger and before lighting the stove, always remember to empty the brazier and check that the brazier is clean. Never empty the brazier inside the hopper.

 After each maintenance operation, make sure that the brazier is positioned correctly in its seat.

 In models with self-cleaning brazier it is not necessary to remove the pellets in the brazier: the pellets loaded are sufficient for subsequent ignition.

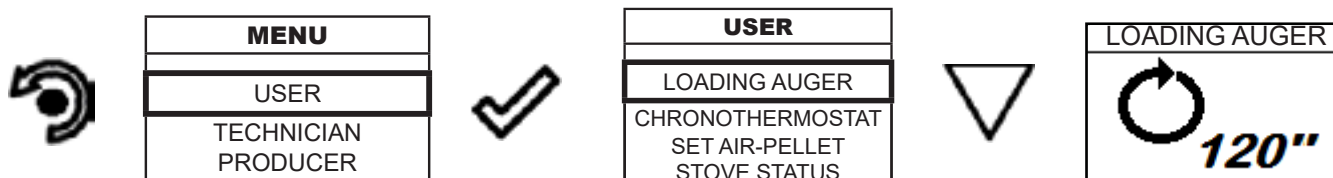

Press the "menu access" button to access the MENU screen.

Press the "confirm" button to access the USER screen

Press the "confirm" button to activate feed screw rotation

Switching the appliance on and off

From the "Home" screen, it is possible to switch the stove on and off by keeping the ON / OFF button pressed on the device for a few seconds. An acoustic signal will warn you that the appliance has switched on or off. In case it is not possible using your handheld you can switch the appliance on / off using the appropriate button on the electronic board.

 Do not switch off the heater by unplugging the plug from the wall socket.

 The appearance of the "SET RDS" message indicates that the initial parameter testing and calibration procedure was not carried out correctly. This indication does not imply blocking the stove (see SIGNALING POP UP section).

Failed ignition

If the system does not detect the ignition of the flame within the preset time, operation will be blocked with the “No ignition” alarm. Before relighting the stove, check that there are pellets in the hopper, that the door and ash drawer compartment are closed, that there are no obstructions to the combustion air inlet system and above all that, in models without self-cleaning brazier, the brazier is empty, clean and correctly positioned. If the problem persists, it could be due to a technical problem (ignition plug, adjustments, etc ...), so please contact a Ravelli CAT.



The accumulation of unburned pellets in the brazier after a failed ignition must be removed before proceeding with a new ignition.



The brazier could be very hot: danger of burns!



Never empty the brazier inside the hopper.

Setting operating temperature and power:

Set the two values following the indications given in the chapter “Description of the display”

OPERATING PHASES OF THE APPLIANCE

Sequence of ignition phases

IGNITION - initial pellet loading phase;

FLAME LIGHT - flame stabilization phase and reduction of combustibile inside the brazier;



WORK - operation phase described in the dedicated chapter;



Modulation

During the work phase, the appliance should reach the room temperature set; when this condition is met, the stove switches to MODULATION mode in which fuel consumption is minimum.

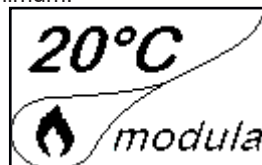

If you wish to detect the ambient temperature by means of an external thermostat (optional), this must be connected to the appropriate connector on the rear side of the stove; and you will have to activate the reading in “SETTINGS - ENABLE THERMOSTAT.” On display appears the writing TON / TOFF based on thermostat request.



Connect an external thermostat with a simple dry contact, therefore, not powered, moreover, we recommend you use a thermostat with a minimum offset of 3°C if you intend to use the comfort clima function.

Description of menu functions



Press the key to access the MENU page

MENU
USER
TECHNICIAN PRODUCER



The TECHNICIAN and PRODUCER menus are password protected. Changing parameters within these menus could compromise the operation and safety of the stove. In this case the warranty will be invalidated.

Chronothermostat

With the Chrono-thermostat function you can program the automatic switch ON/OFF of the stove for each day of the week for each day of the week in 4 independent time intervals (SET CHRONO 1-2-3-4). Below are given the steps for accessing the relative menu starting from "Home" mode.

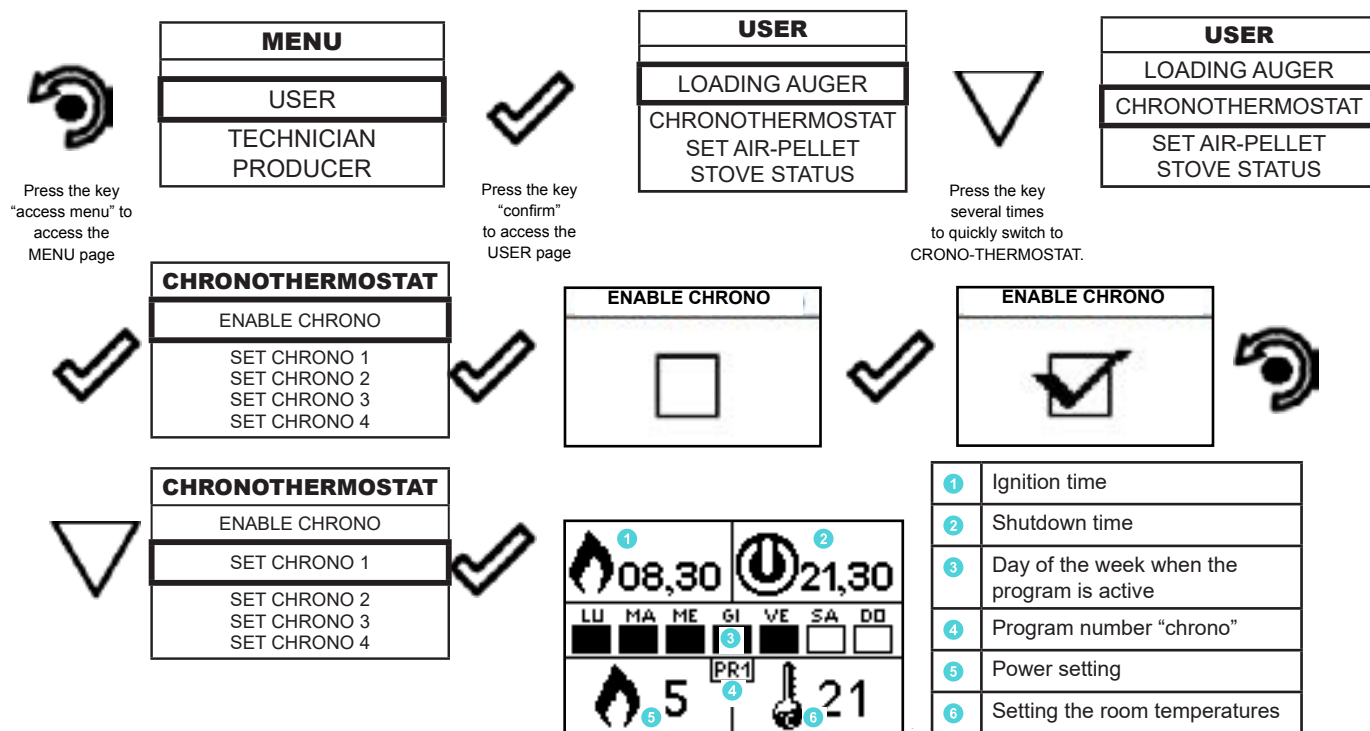

The exit key shows the CHRONO menu to set other variables related to the menu functions.

To exit the page and return to "Home" page, press the button repeatedly.

Set air - pellet

The setting of the PELLET-FLOW mixture allows to adjust the combustion by varying the quantity of pellets loaded in the brazier and/or the quantity of air. In fact, by its nature, pellets vary in grain size and composition: even bags of pellets of the same brand can have different characteristics.

If combustion is not optimal, vary the flow parameter to adjust the combustion air. If air regulation alone is not sufficient, it may also be necessary to modify the pellet parameter.

! Combustion regulation is an operation that requires a lot of experience. We recommend that you contact an Authorised Service Centre to calibrate the stove appropriately.

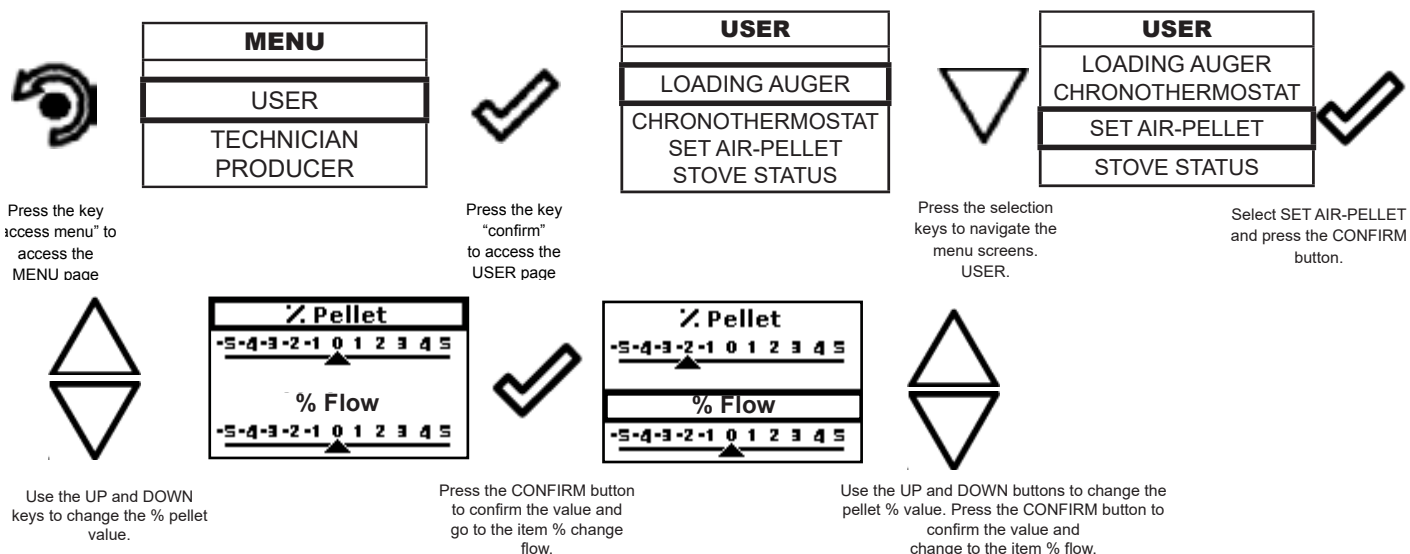

To exit the screen and return to the home screen, press the key repeatedly.

Stove status

Below are given the steps for accessing the relative menu starting from "Home" mode.

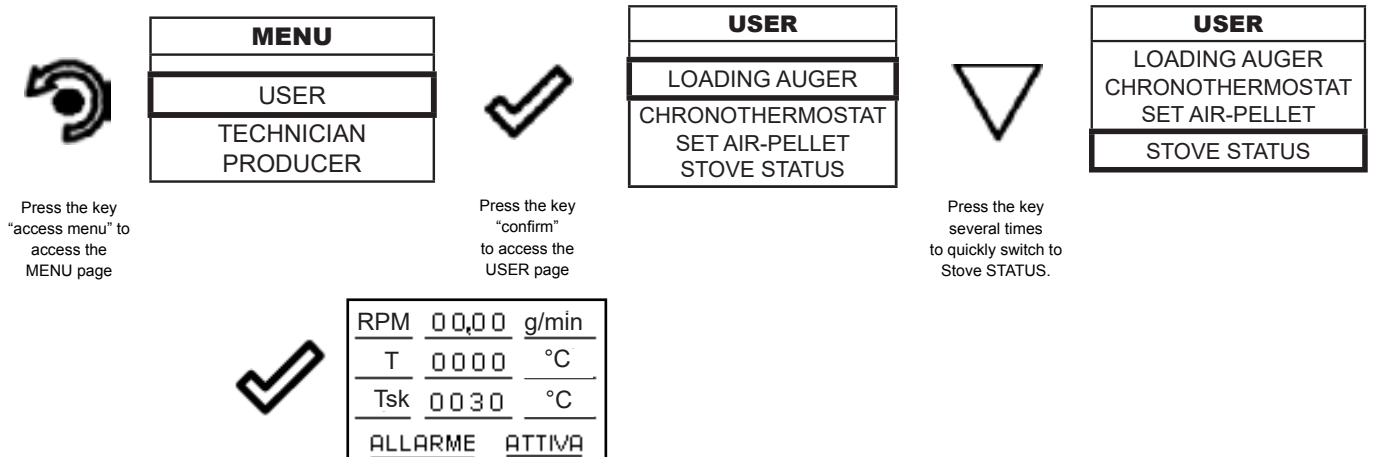

In this mode you can check the proper operation of the most important parameters of the appliance. Here is a list of real data of the stove useful for service during inspection.

- RDS current reading RDS (m/s)
- RPM current smoke extractor speed (rpm)
- T fumes temperature (°C)
- Indication of stove status
- SET set value RDS (m/s)
- Df cold probe temperature RDS (°C)
- Sk: electronic board temperature (°C)

To exit the STOVE STATUS screen and return to the Home screen, press the key repeatedly.

Comfort clima

The activation of this function enables the stove to reduce pellet consumption by activating the modulation phases, after the desired temperature has been reached. Subsequently, the stove checks that the temperature is maintained steady for a preset time (DELAY SWITCH OFF). If this condition is met, it automatically switches off, and on display appears the writing ECO. The stove turns on again when the temperature drops below the set threshold (DELTA RESTART).

Below are given the steps for accessing the relative menu.

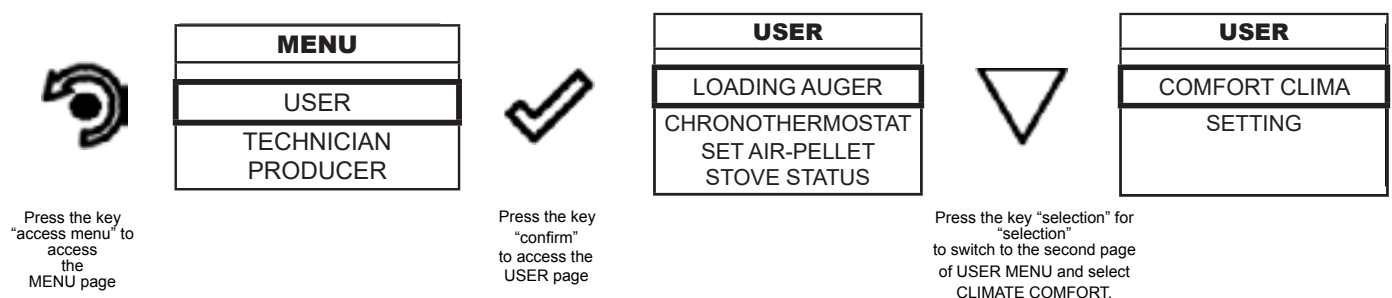

Once you have accessed the Comfort Clima menu, it is possible to operate on the 3 types of settings dedicated to the function:

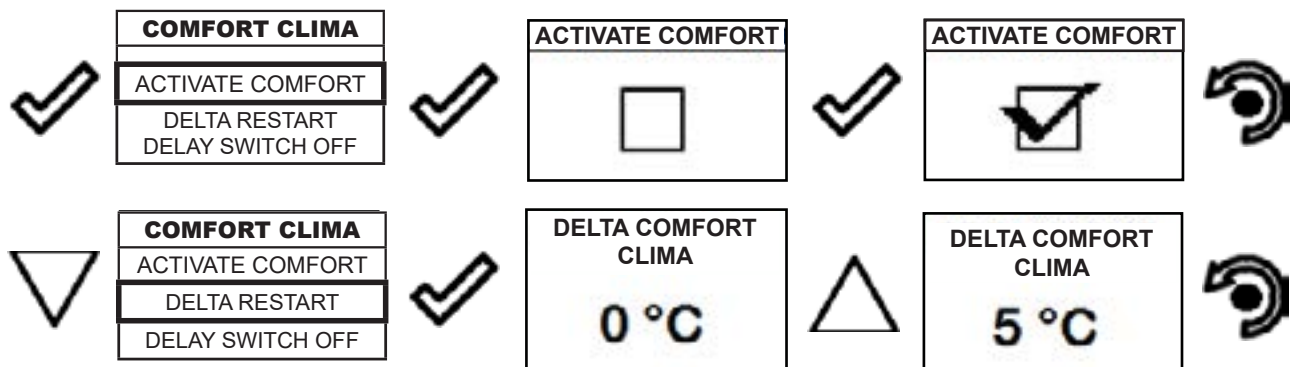

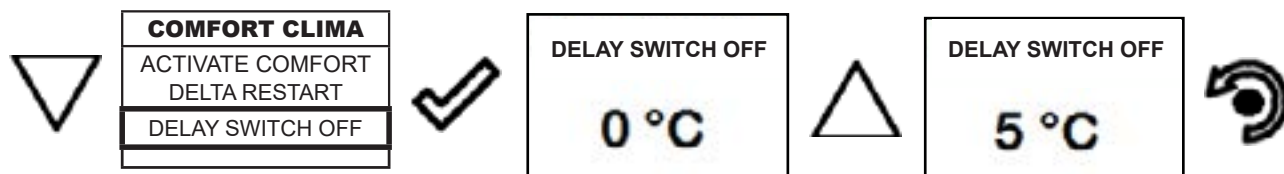

The first setting allows the activation of the COMFORT CLIMA function. This function is intended to ensure that the room temperature set is maintained steady upon setting the maximum period of "X" minutes (SWITCH-OFF DELTA Y: 5 MIN) before switching to ECO STOP phase. The STOVE maintains this state until the temperature drops below the set value (DELTA COMFORT CLIMA: 5°C). For example, with the room temperature at 21 °C, the stove switches off when this temperature is reached and restarts when the temperature reaches 16°C (21°C - 5°C). You can also activate the function using an external thermostat, keeping in mind that this does not include the value of hysteresis.

Setting

Below are the steps to follow, starting from the Home screen, to access the Home menu.

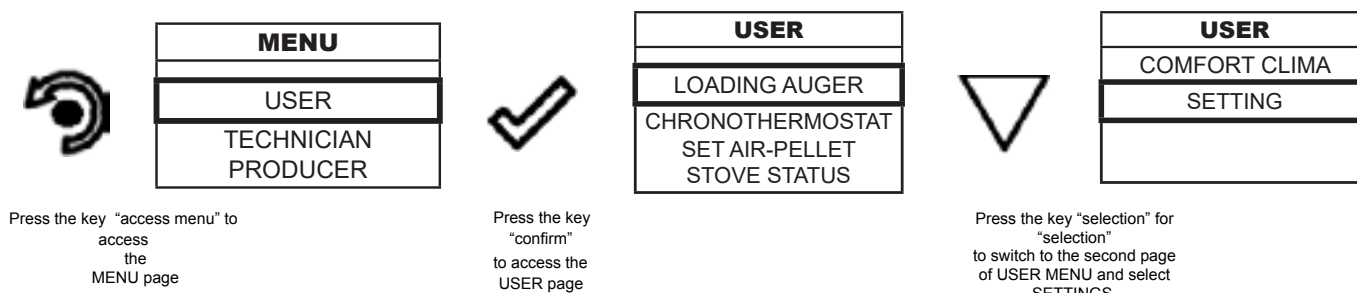

After following the above procedure

Settings > Enable thermostat

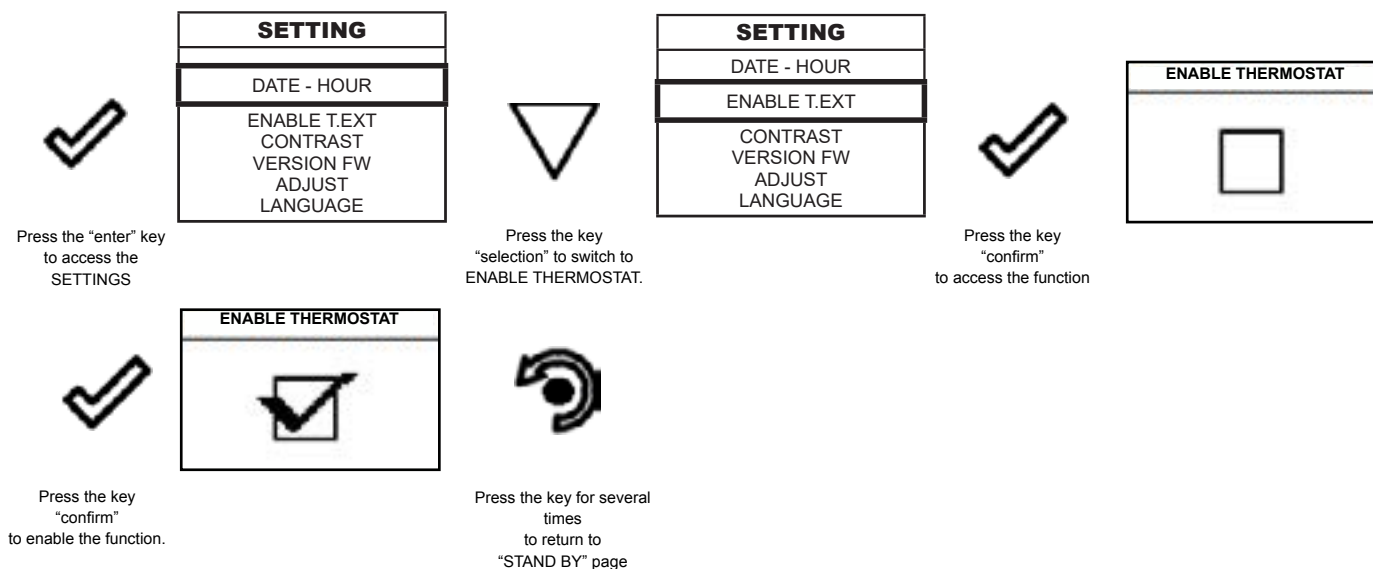

In "Home" mode, instead of room temperature measured and settable, appears the line T ON if the room in which the thermostat is installed has not reached the temperature requested or the writing T OFF if the temperature in the room is reached.

Settings > Contrast

With this function you can change the contrast setting to improve the display of your handheld. The contrast setting to improve the display of the handheld display.

Press the key "confirm" to access the SETUP SETTINGS

SETTING
DATE - HOUR
ENABLE T.EXT CONTRAST VERSION FW ADJUST LANGUAGE

Press the key "selection" to switch to the function CONTRAST.

SETTING
DATE - HOUR ENABLE T.EXT
CONTRAST
VERSION FW ADJUST LANGUAGE

Press the key "confirm" to access the function

CONTRAST
50

Use the UP/DOWN keys to change contrast setting and obtain a better visualisation of the information shown on the handheld set. The value can vary from 0 to 100. 50 with respect to the standard value.

By pressing the following key you will confirm of data and switch to the page within SETTINGS menu.

Settings > Firmware version

Press the "enter" key to access the SETTINGS

SETTING
DATE - HOUR
ENABLE T.EXT CONTRAST VERSION FW ADJUST LANGUAGE

Press the key "selection" to switch to CONTRAST.

SETTING
DATE - HOUR ENABLE T.EXT CONTRAST
VERSION FW
ADJUST LANGUAGE

Press the key "confirm" to access the function

FIRMWARE
AIR_TOUCH_MB01.00
SNELLINA
AIR_TOUCH_UI01.00

By pressing the button you will confirm the data and switch to the page within the SETTINGS menu.

Settings > Adjust

The adjust function allows to modify the value read by the room probe inside the handheld computer, increasing or decreasing it by the set value (offset).

Make this adjustment carefully and only after having checked deviations from the actual room temperature with a reliable instrument!

Press the key "confirm" to access the SETUP SETTINGS

SETTING
DATE - HOUR
ENABLE T.EXT CONTRAST VERSION FW ADJUST LANGUAGE

Press the key "selection" to switch to the function VERSION FW.

SETTING
DATE - HOUR ENABLE T.EXT CONTRAST VERSION FW
ADJUST
LANGUAGE

Press the key "confirm" to access the function

ADJUST
0° C

UP" and "DOWN" buttons The value can vary from -10°C to 10°C. The standard value is 0°C.

Pressing the following key allows you to confirm the data and move to the screen within the SETTINGS menu.

Settings > Language

To access the next setting, follow the steps given above or simply remove and replace the batteries.

The device resets and prompts you again to select the language you want to set.

Double ducting

This function allows you to manage distribution of warm air between the room where the stove is installed and the rooms where the duct arrives.

The function has two operating modes: manual and automatic.

Manual mode: the user manually sets distribution of warm air between front ventilation and ductings.

Automatic mode: the stove automatically manages distribution of warm air between front ventilation and ductings, according to the temperatures in the rooms.

Management

The following are the steps to be followed to access the relative menu, starting from the Home screen.

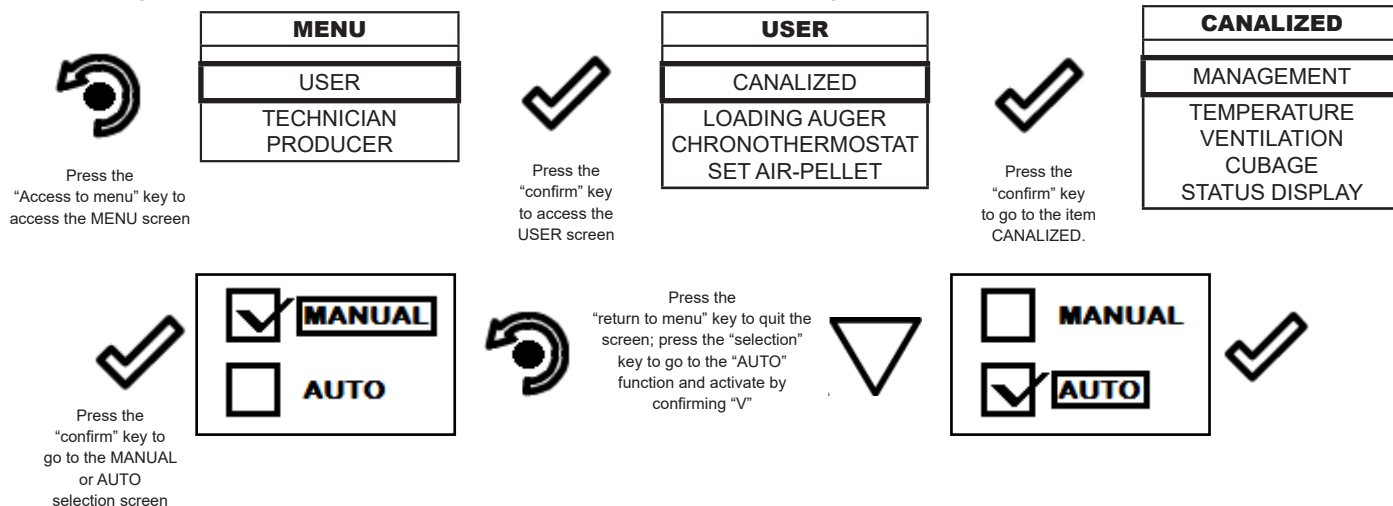

Pressing exit brings you to the CANALIZED menu to set the other function variables in the menu.

Press the key repeatedly to exit the MANAGEMENT screen and to go back to the "Home" screen.

Ventilation (manual mode)

When manual management is active, the power of the ducting can be changed.

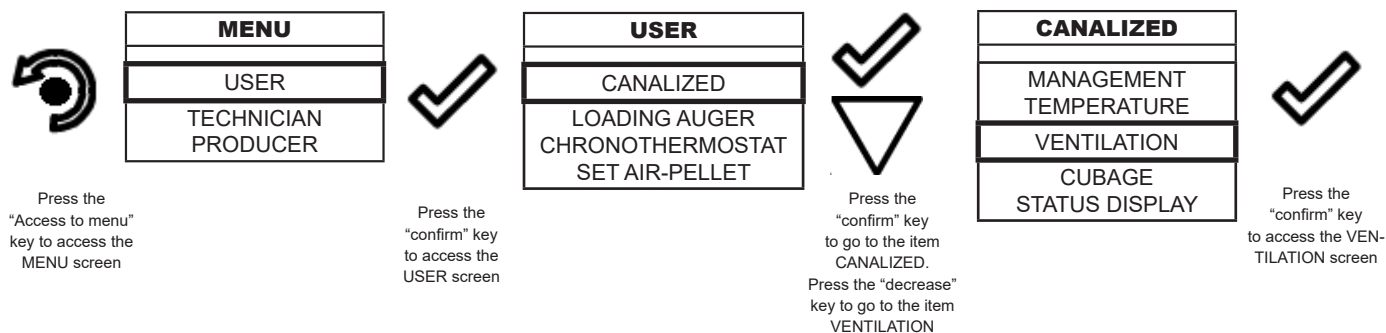

In the VENTILATION item, there is the following screen: the upper line of the display shows the power of the front ventilation, the lower part of the display shows the distribution of hot air between the ducts.

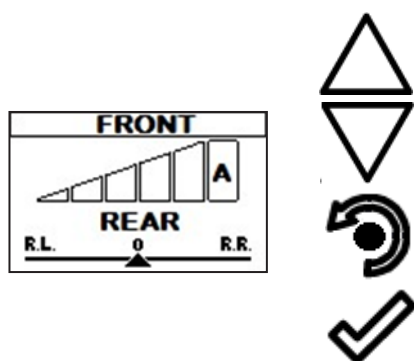

Use the "UP" and "DOWN" keys to change the power of the front ventilation (the data is saved without further confirmation). The value can be chosen from 0 (front ventilation off) to 5. By setting A (auto) the power of the ventilation follows the power of the stove (on some models this setting can be limited or disabled).

To go back to the CANALIZED menu, press the "back" key.

Use the "confirm" button to switch to setting the distribution of the hot air in the ducting (REAR)

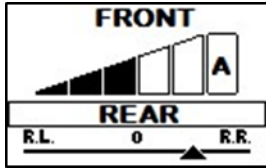

Use the “UP” and “DOWN” keys to change the distribution of hot air between right and left ducting (the data is saved without further confirmation). You can choose from five different positions.

To go back to the CANALIZED menu, press the “back” key.

Use the “confirm” button to switch to setting the distribution of the hot air in the ducting (REAR)

To go back to the CANALIZED menu, press the “back” key once; to go back to the Home screen, press the “back” key several times.

Depending on the chosen settings, the following combinations are possible

	<i>R.L.</i> Rear Left	<i>R.L. - 0</i>	<i>0</i> (Balanced)	<i>0 - R.R.</i>	<i>R.R.</i> Rear Right
Frontal ventilation	from OFF to A	from OFF to A	from OFF to A	from OFF to A	from OFF to A
Right ducting	15%	40%	65%	85%	100%
Left ducting	100%	85%	65%	40%	15%



The TEMPERATURE and CUBATURE submenus cannot be accessed when in manual mode.

Temperature (automatic mode)

When automatic management is active, the power of the stove and the speed of the fans are automatically managed so that the desired temperatures are reached and maintained in the rooms heated by the ducting. To use this function you must connect temperature probes or external thermostats.

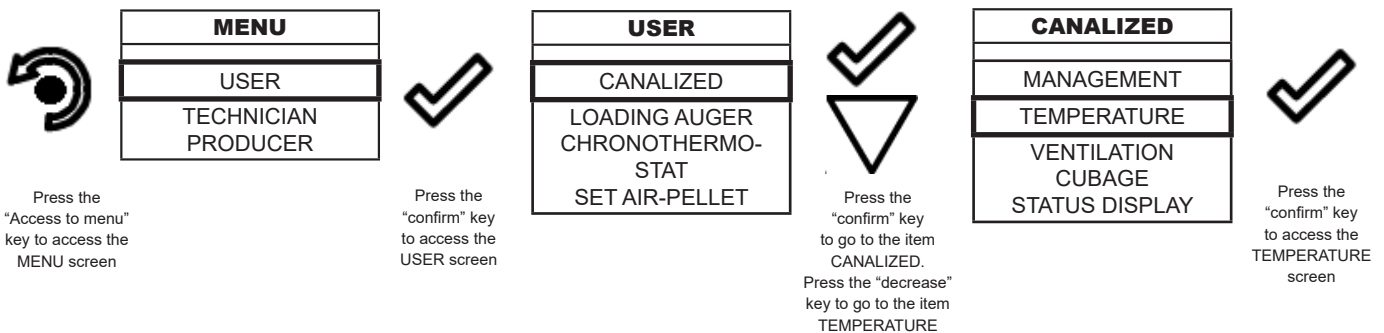

In the TEMPERATURE item, there is the following screen:



Use the “UP” and “DOWN” keys to modify the desired temperature in the room rooms heated by the ducting (the data is saved without further confirmation).

To go back to the CANALIZED menu, press the “back” key.

Use the “confirm” button to go to the enable external thermostat item (ENABLE T.EXT.).



To go back to the T.REAR RIGHT menu, press the “back” key.



To go back to the T.REAR LEFT menu, press the “increase” key.



Use the “confirm” button to enable / disable the external thermostat.

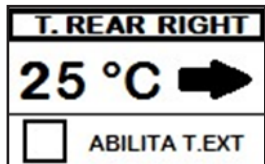

Use the “UP” and “DOWN” keys to modify the desired temperature in the room rooms heated by the ducting (the data is saved without further confirmation).



To go back to the CANALIZED menu, press the “back” key.



Use the “confirm” button to go to the enable external thermostat item (ENABLE T.EXT.).



To go back to the CANALIZED menu, press the “back” key once; to go back to the Home screen, press the “back” key several times.



To go back to the T.REAR RIGHT menu, press the “increase” key.



Use the “confirm” button to enable / disable the external thermostat.

Cubature

To optimise automatic mode, set the cubature difference (m³) of the rooms during the installation stage.

You may choose from three options:

EQUAL: if the room heated by the right channeling and the room heated by the left channeling have similar volume;

REAR LEFT: if the room heated by the left duct is larger than the room heated by the right duct;

REAR RIGHT: if the room heated by the right channel is larger than the room heated by the left channel.

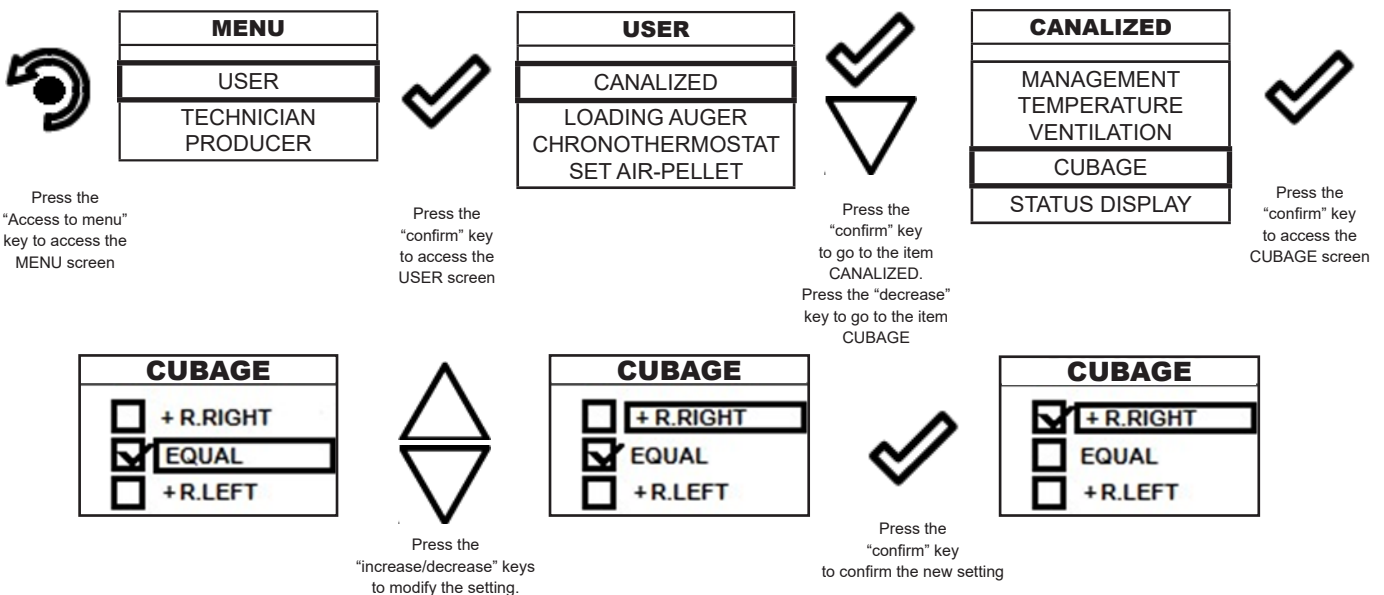

To exit the screen to go back to the CANALIZED menu, press the “back” key once; to go back to the Home screen, press the “back” key several times.

Display of double ducting status

The following are the steps to be followed to access the status display, starting from the "Home" screen.

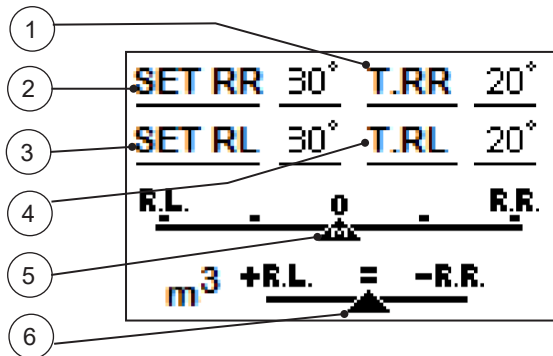
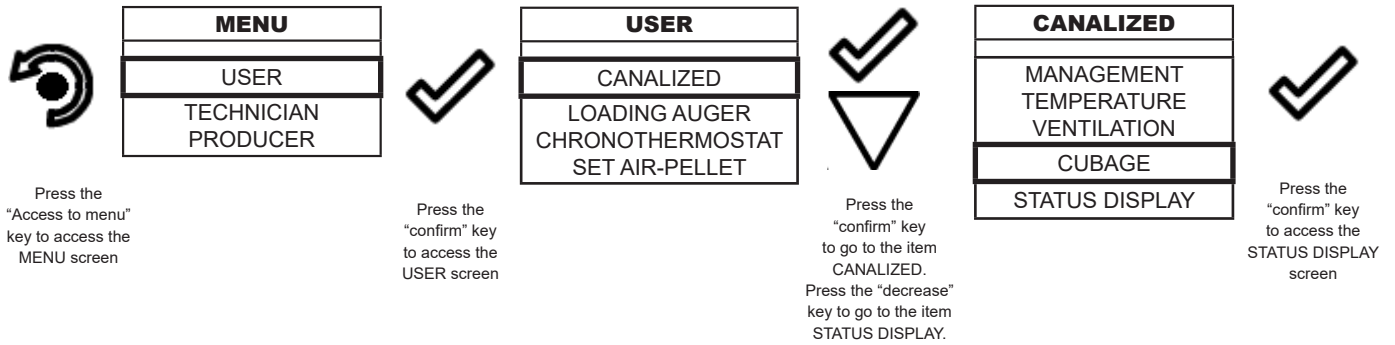













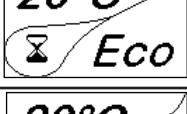

- 1- Temperature read by the probe placed in the rooms heated by the right ducting;
- 2- Right ducting temperature set (not considered in manual mode);
- 3- Left ducting temperature set (not considered in manual mode);
- 4- Temperature read by the probe placed in the rooms heated by the right ducting;
- 5- Distribution of the ducting (A = Auto, M = manual);
- 6- Volume of rooms.

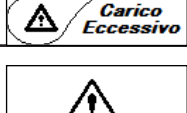
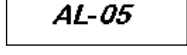

To exit the screen to go back to the CANALIZED menu, press the "back" key once; to go back to the Home screen, press the "back" key several times.

Stove phase general layout

	PHASE	DESCRIPTION
	FINAL CLEANING	The stove is in the switch off phase and the cooling phase has not been completed yet.
	SWITCH ON	The heater pre-heating phase has started and the pellets start to fall into the grate.
	FLAME LIGHT	The pellets ignite and take advantage of the heat in the intake air that passes through the incandescent heater tube.
	WORK	The stove has completed the switch on phase and runs at maximum set power
	MODULATION	The room temperature set has been reached.
	FIRE POT CLEANING	Fire pot cleaning phase is active (periodic function).
	ECO STOP	With Climate Comfort active, the stove switches to automatic switch-off mode when the room temperature set is reached (see the dedicated section).
	WAITING START / RESTART	Switch-on is requested but with the stove in cooling phase; once this condition is met, it restarts automatically.
	IGNITION RESTART	The HOT restart phase is activated. Functioning is similar to the SWITCH ON phase
	HOT SMOKES	The maximum fume temperature threshold has been reached. To facilitate cooling, the stove brings the capacity to a minimum with ventilation at power level 5, leading to a decrease in fume temperature.
	OFF	The stove is off
	WAIT FOR PELLETS OUT OF	When the switch-on request from ECO STOP mode coincides with an automatic switch-off condition (from the TIMER), the stove turns on ensuring total cleaning of the fire pot before switching to FINAL CLEANING.
	AUGER OVERFLOW	CONDITION: when the pellet setting (set pellets +5) is near the continuous load condition. SOLUTION: Set the value back to 0.
	ALARM (generic)	The stove is in alarm state; refer to the troubleshooting chapter.

	ANOMALY (general)	The stove has detected an anomaly; refer to the troubleshooting chapter. By pressing the confirmation key, the problem is described.
--	--------------------------	---

Warning Pop -Up

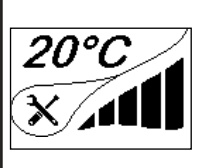
	ANOMALY	DESCRIPTION
	SERVICE REQUEST	The threshold value of set work hours has been reached. The symbol displayed remains active throughout the work phase. Non-routine maintenance is required on the stove.

Alarms (table with reference codes)

	TITLE	REASON	SOLUTION
AL 01	BLACK OUT	No voltage during work phase	Press the switch off key and switch on the stove again If the problem persists, contact the Support Service
AL 02	SMOKE PROBE FAILURE	The smoke probe is malfunctioning The smoke probe is disconnected from the electronic board	Contact the Support Service Contact the Support Service
AL 03	OVERTEMP. SMOKE	Combustion in the fire pot is not optimal due to clogging or obstructions of internal stove ducts inside the stove	Switch off the stove, clean the fire pot and the tube bundle and adjust the combustion setting the Pellet/Air values Contact the Support Service If the problem persists, contact the Support Service
AL 04	FAN BROKEN	Fume exhaust encoder is not working or is connected incorrectly No power to fume extractor. The fume extractor is blocked.	Contact the Support Service Contact the Support Service Contact the Support Service
AL 05	NO IGNITION	The pellet tank is empty. Pellet calibration and suction during switch on phase is incorrect. The ignition coil is faulty or positioned incorrectly	Check for the presence of pellets in the container. Top up, if necessary. Contact the Support Service Contact the Support Service
AL 06	NO PELLETS	The pellet tank is empty. The gear motor is not loading pellets. Not enough pellets loaded	Check for the presence of pellets in the container. Top up, if necessary. Empty the tank to see if there are any objects inside that may prevent proper operation of the auger. Regulate pellets setting from "SET AIR/PELLETS" If the problem persists, contact the Support Service
AL 07	RESETTABLE THERMAL BREAKER	The manual reset thermostat connected to the hopper has been triggered Combustion in the fire pot is not optimal due to clogging or obstructions of internal stove ducts inside the stove	Reset the thermostat by pressing the button on the back of the stove Switch off the stove, clean the fire pot and the tube bundle and adjust the combustion setting the Pellet/Air values Contact the Support Service
AL 08	DEPRESSION	The flue is blocked. The vacuum meter is faulty.	Check the flue is free and clean Check the mains voltage.

AL 12	FUME EXHAUST SYSTEM	The fume exhaust system has a loss of performance due to fan obstruction or voltage drop.	Check the mains voltage.
AL 14	AUGER PHASE	No cable connection to power the gear motor	Check the mains voltage.
AL 15	AUGER TRIAC	An internal part of the electronic board that controls the pellet auger is faulty.	Check the flue is free and clean
		Possible voltage drops or incorrect input voltage	Check the mains voltage.

MAINTENANCE

Safety warnings for maintenance

Maintenance of the stove must be performed at least once a year and should be planned in advance with the Technical Assistance Service.

In some conditions, such as turning the stove on and off or inappropriate use, the combustion products can contain small soot particles that build up in the smoke evacuation system. This can reduce the cross-section of the smoke duct and pose a fire risk. The smoke evacuation system must be inspected and cleaned at least once a year.

The maintenance operations must be carried out when the stove is cold and with the electrical power supply disconnected.

Before completing any maintenance operation, adopt the following precautions:

- Make sure that all stove parts are cold.
- Make sure that the ashes are completely cold.
- Always operate with equipment that is appropriate for maintenance.
- When maintenance is finished, re-install all of the dis-assembled parts before restarting operation.

The quality of the pellet, the stove operating mode and combustion control can affect maintenance activity frequency.

Cleaning

Perform the cleaning operations so as to guarantee correct stove operation.

The table below lists the necessary cleaning operations required for correct stove operation.

PARTS / FREQUENCY	2-3 DAYS	30 DAYS	60/90 DAYS
Ash drawer		•	
Glass	•		
Scraper	•		
Combustion chamber		•	
Pellet tank		•	
Extraction duct			•

In the first periods of use, carry out cleaning operations frequently to understand the right frequency of intervention, which varies according to the installation, use, pellet used, etc.

Cleaning the ash drawer

The ash drawer must be cleaned every 30 days, (depending on the amount of time the stove is used and what type of pellet is used).

To clean the ash drawer, proceed as follows:

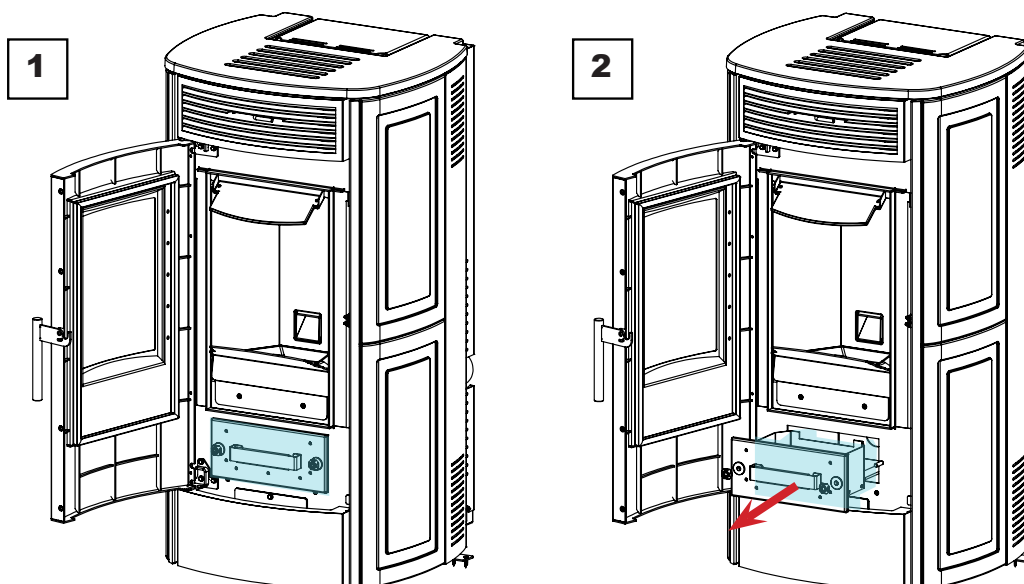

Glass cleaning

With a cold stove, clean the glass with a cloth and glass cleaner.

Note: there are stove glass cleaning products available on the market.

Cleaning the tube heat exchanger:

During operation, dust and soot are deposited on the surface of the heat exchanger tubes. To ensure smooth operation throughout the season, it is advisable to periodically clean the heat exchanger when the stove is cold. Using the cold handle, extract the scraper rod and firmly move the scraper back and forth.

Once you have finished cleaning the exchanger, push the scraper into the grille (never leave it removed).

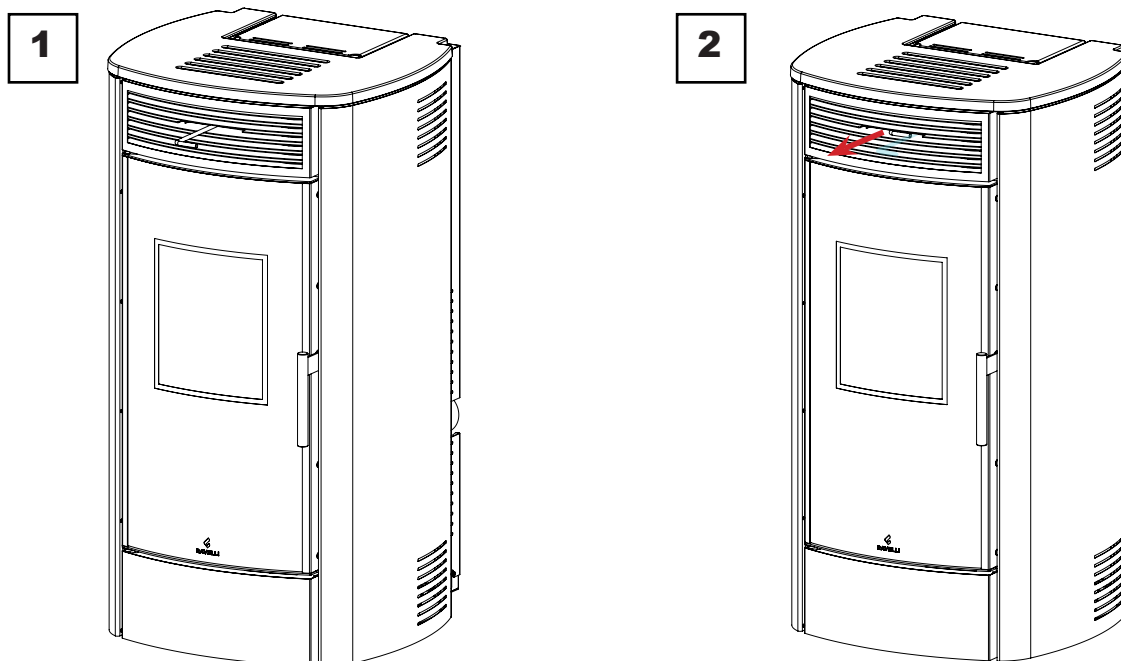

Combustion chamber cleaning

To clean the ash drawer, proceed as follows:

step	action
1	The stove requires a simple yet frequent cleaning in order to guarantee suitable yield and regular operation. Vacuum the combustion chamber every day using a bin ash vacuum, making sure that the ashes are completely cold.

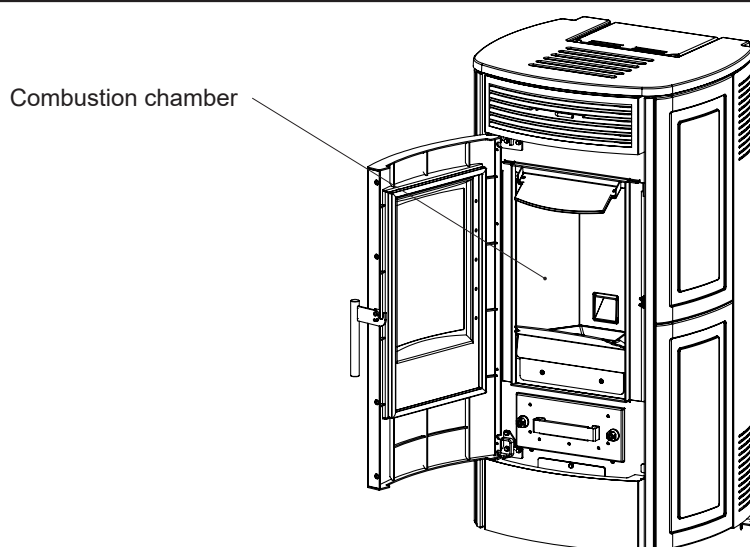

Cleaning the pellet tank

To clean the pellet tank, proceed as follows:

step	action
1	Periodically remove the wood sawdust accumulated on the bottom of the tank, using a vacuum cleaner.

Extraction duct cleaning

Periodically check that the extraction duct is free from obstructions (dust, animal hair ...) and remove them if necessary.

Extraordinary maintenance

! Extraordinary maintenance activities must be carried out by staff from the Authorised Assistance Centre.

! Do not wait for components to be deteriorated by use before proceeding with their replacement. Replace a worn component before it is completely broken to prevent any damage caused by sudden component breakage.

PARTS/ FREQUENCY	1 SEASON
Deep combustion chamber cleaning	•
Door gasket	•
Chimney	•
Smoke conduit	•

Schedule the above extraordinary maintenance activities with the Authorised Assistance Centre.

Deep combustion chamber cleaning

+ This operation must be carried out by a Ravelli Assistance Centre.

+ Schedule this type of cleaning with the Ravelli Assistance Centre.

To clean the combustion chamber, proceed as described below:

After cleaning the combustion chamber, it is advisable to proceed with the cleaning of the inspection hatches as indicated in the paragraph "Smoke duct cleaning".

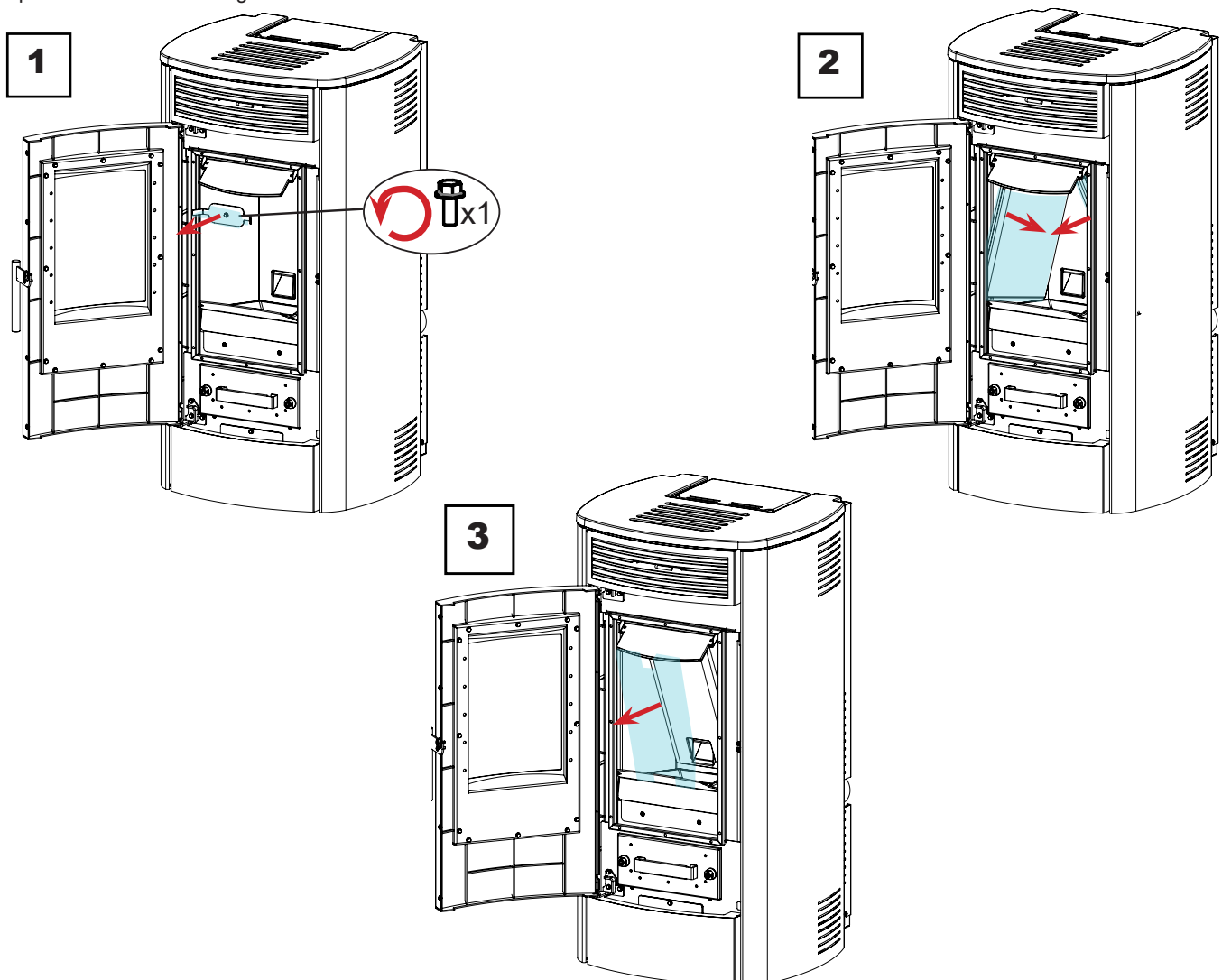

Checking the seals



This operation must be carried out by a Ravelli Service Centre. Plan this type of cleaning with the Ravelli Service Centre.

When thoroughly cleaning the stove, the authorised technician must check that the gaskets of

- port
- ash drawer
- hatches

are intact. If not, they will have to be replaced.

Smoke conduit cleaning



This operation must be carried out by a Ravelli Assistance Centre. Schedule this type of cleaning with the Ravelli Assistance Centre.

The stove is equipped with some hatches for cleaning the internal smoke ducts.

To clean the smoke ducts, proceed as described below:

step	action
1	Remove claddings.
2	Open the hatches.
3	Clean the ashes, eventually use a brush or similar and reassemble everything. Note: the hatches are equipped with gaskets, therefore, before reassembling them, make sure that the gaskets are not worn.

Note: The operation must be carried out when the stove is cold, using an ash vacuum cleaner.

Sphere Decò

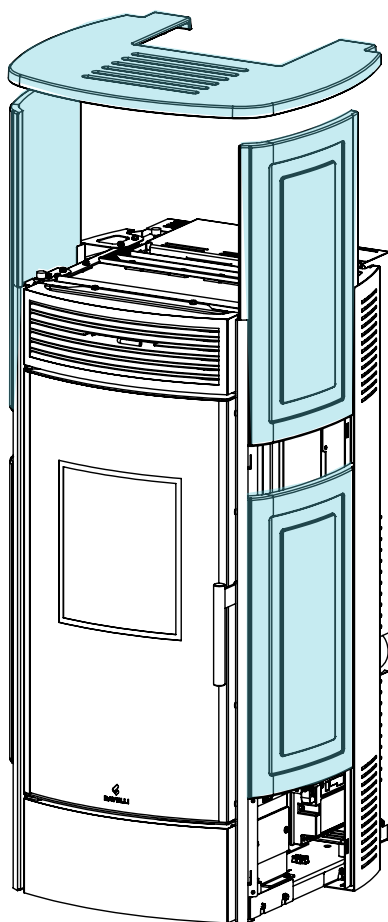
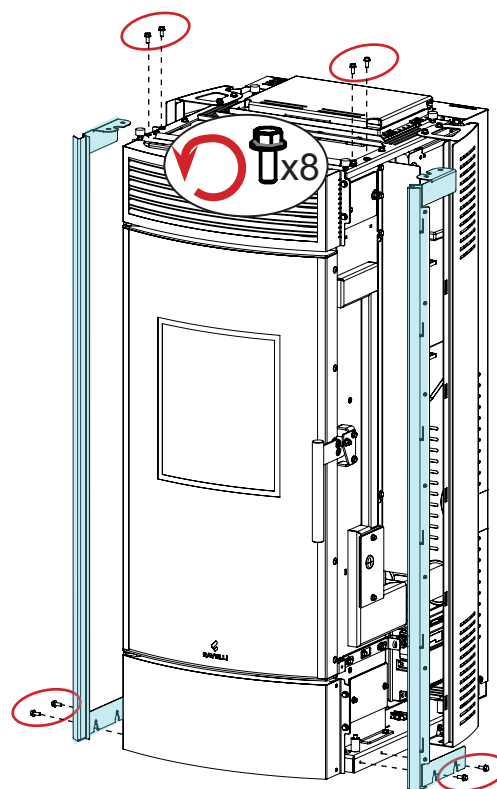
1a

1b

Sphere Steel

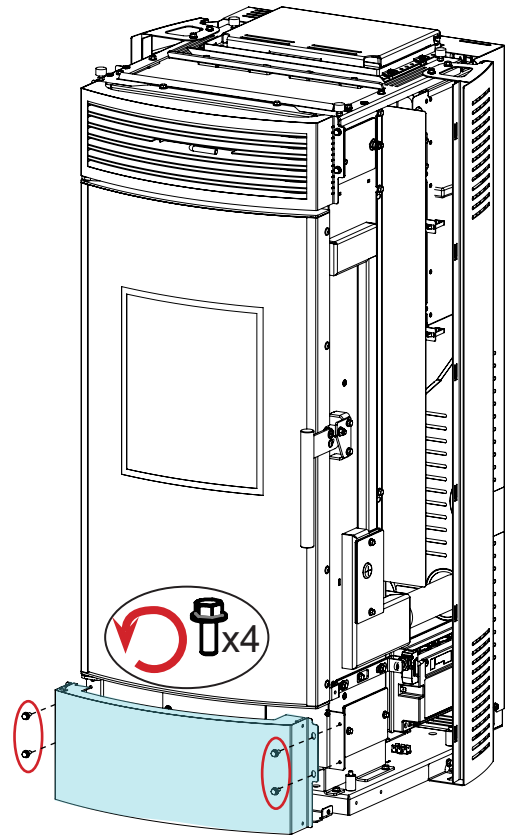
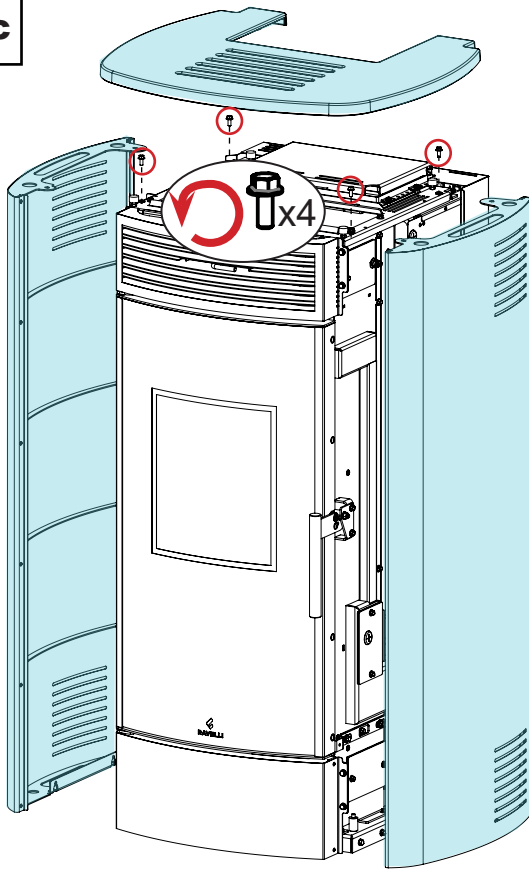
1c

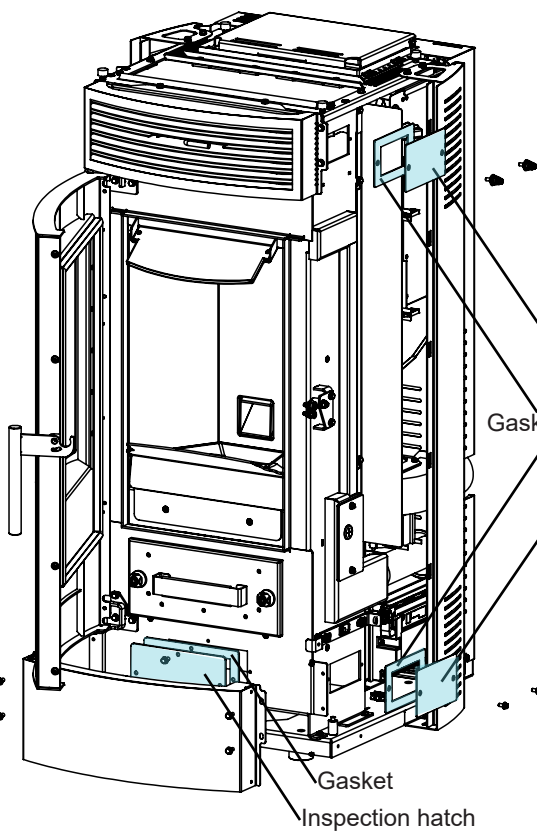

2



3

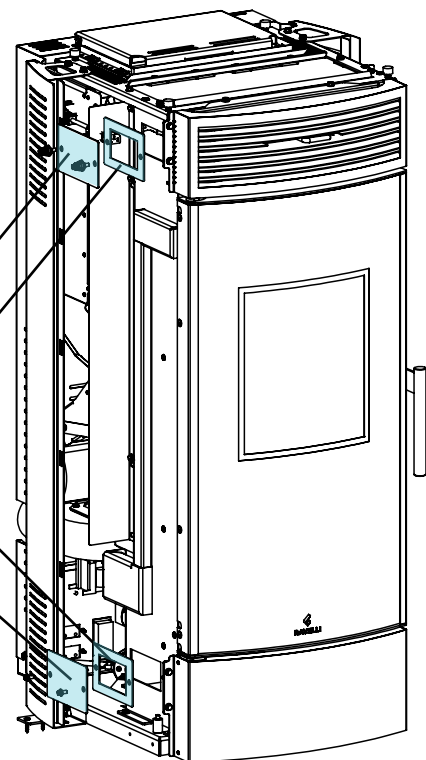

Gasket Inspection hatch Gasket

Gasket Inspection hatch

Failure cases

Problem	Causes	Possible remedies	Alarm signal
No pellets are loaded into the combustion chamber	The pellet tank is empty	Load the pellets into the tank	AL 05 AL 06
	The auger is blocked	Empty the tank to check that no objects have fallen inside that prevent the auger from rotating	AL 05 AL 06
	The auger rotates but no pellets are loaded	Check that the pellet feed channel into the combustion chamber is free from obstructions, such as sawdust, stuck pellets or other objects. In this case, free from obstruction, it is advisable to contact the Technical Assistance Service.	AL 05 AL 06
	Faulty gearmotor	Replace the gearmotor (contact the Technical Assistance Service.)	AL 05 AL 06
	Defective electronic board	Replace the electronic board (contact the Technical Assistance Service.)	
	Triac failed	Replace the electronic board (contact the Technical Assistance Service.)	AL 15
The flame does not ignite	Check that the igniter warms up	Check and, if necessary, replace the igniter	AL 05
	Air inlet duct blocked	Check the patency of the air inlet duct	
	Incrustations in the brazier that block the passage of air from the igniter	Verification and removal of incrustations	AL 05
	Pellet loaded in insufficient ignition	It is advisable to contact the Technical Assistance Service to have the initial load adjusted.	AL 05
Excessive gas formation during stove ignition	Excessive load of pellets during ignition	It is advisable to contact the Technical Assistance Service to have the initial load adjusted.	
	Obstructed drain	Clean the smoke duct	
	 In case of excessive gas formation inside the combustion chamber during the ignition phase, it is advisable not to stand in front of the stove and not to approach the combustion chamber glass, but to wait for the flame to ignite in a safe place . For more information see the paragraph "What to do in case of overload during ignition"		

Problem	Causes	Possible remedies	Alarm signal
The flame goes out	The pellet tank is empty.	Load the pellets into the tank	AL 05 AL 06
	Pellet is not loaded	See previous problem	AL 05 AL 06
	The safety reset thermostat has intervened	Check that the water is free to circulate in the stove and in the system, for example by checking the shut-off valves. Let the stove cool down, reset the reset thermostat, reset the alarm and turn the appliance back on; if the problem persists, contact the technical assistance service	AL 07
	Open combustion chamber door and / or ash drawer.	Close the combustion chamber door, the ash drawer or the hopper lid	AL 07
	Water pressure too high or too low	Check the plumbing system	AL 16
	Inadequate pellets	Change the type of pellets with one recommended by the manufacturer	AL 05 AL 06
	Inadequate air / pellet ratio	Adjust the "AIR-PELLET SET" setting: decrease the air set and, if necessary, increase the pellet set	AL 05 AL 06
	Dirty combustion chamber	Clean the combustion chamber following the instructions in the booklet	AL 05 AL 06
	Smoke extraction motor failure	Check and replace the motor if necessary	AL 04
	Obstructed drain	Clean the smoke duct	AL 08
The stove stops automatically	The door is not closed perfectly or the gasket are worn	Close the door and have the gaskets replaced with original ones	AL 05 AL 06
	Alarm presence	Check the alarm table	(Any alarm)
	Active chronothermostat	Check if the chronothermostat is active	
The pellets accumulate in the brazier and the flame is weak	External thermostat enabled	Check the settings of the external thermostat	
	Insufficient combustion air	Make sure that the air intake in the room is present and free	
	The door is not closed perfectly or the gasket are worn	Close the door and have the gaskets replaced with original ones	
	Smoke duct blocked	Clean the smoke duct	
	Inadequate air / pellet ratio	Adjust the "AIR-PELLET SET" setting: decrease the air set and, if necessary, increase the pellet set	
	Wet or inadequate pellets	Change the type of pellets	
The flue gas fan does not work	Smoke extraction motor faulty	Check and replace the motor if necessary	AL 04
	The engine is broken	Check the motor, the capacitor, and the wiring and replace them if necessary	AL 04
The air fan never stops	The card is defective	Replace the electronic board	
	Fume probe faulty or broken	Check the operation of the probe and replace it if necessary	
The air fan does not turn on	Defective electronic board	Replace the electronic board	
	The appliance has not reached the threshold temperature	Please wait	
	The air fan is broken	Replace the fan	

Problem	Causes	Possible remedies	Alarm signal
No communication between the stove and the remote control	Remote control not associated with the stove	Pair the remote control to the stove following the instructions given here	
	Radio interference	Evaluate the presence of other radio devices in the vicinity	
	Remote control firmware not compatible with stove firmware ("LINK" message appears on the display)	Contact the technical assistance service to update the remote control FIRMWARE	
	Communication component of the card or remote control faulty	Replace electronic card or remote control	
The remote control does not work	Remote control battery low	Replace battery or connection to the stove via cable	
	Faulty remote control	Replace remote control	
The stove always works at maximum power	Temperature not set correctly	Set the remote control temperature again	
	Remote control position not optimal for detecting room temperature	Place the remote control in another location	
	Additional temperature probe or external thermostat (if present) faulty	Check probe or thermostat and replace if necessary	
	Defective or broken remote control	Check the remote control and replace if necessary	
The stove does not turn on	Lack of electricity	Check that the power plug is inserted and the switch in the "I / ON" position.	
	Fuse tripped following a fault	Replace the fuse with one having the same characteristics (5x20 mm T 3.15A)	
	Clogged exhaust or smoke duct.	Clean the smoke outlet and / or the smoke duct	

STORAGE AND DISPOSAL

Disposal

Demolition and disposal of the stove is under the exclusive liability and responsibility of the owner who must do so in accordance with the laws in force in the country of installation pertaining to safety, respect and protection of the environment.

At the end of its service life, the product must not be disposed of as household waste. It can be taken to designated separate waste collection centres run by local administrations or to dealers who offer this service.

Disposing of the product as sorted waste avoids any negative consequences on the environment and health deriving from unsuitable disposal and it recovers the materials that the stove is composed of in order to save considerable energy and resources.

TROUBLESHOOTING

The stove does not work

- closely follow the directions in the dedicated chapter of this manual.
- make sure that the air intake duct is not obstructed;
- make sure that the smoke evacuation system is clean and not obstructed;
- make sure the chimney is sized for the stove power;
- make sure that the air intake in the room is clear of any obstructions and that there are no other combustion appliances or extraction hoods that create a vacuum in the room;

Difficult lighting

- closely follow the directions in the dedicated chapter of this manual;
- make sure that the air intake duct is not obstructed;
- make sure that the smoke evacuation system is clean and not obstructed;
- make sure the chimney is sized for the stove power.
- make sure that the air intake in the room is clear of any obstructions and that there are no other combustion appliances or extraction hoods creating a vacuum in the room.

Smoke leakage

- Check the draught of the chimney.
- Check whether the seals on the door, drawer and smoke evacuation system are intact.
- Make sure there is no ash obstructing the primary air flow grille.

The glass gets dirty easily

- Only use recommended fuels.
- Check the draught of the chimney.

Downtime (end of season)

At the end of every season we recommend vacuuming out any ash and dust that may still be inside. It is advisable to let the pellets burn out in the tank so that the pellet remains and sawdust can be vacuumed from the bottom and from the screw.

Disconnect the stove from the power supply.

With thermo-stove or boiler, it is not necessary to empty it of water, but it is advisable to close the shut-off valves at the inlet and outlet for prolonged downtime.

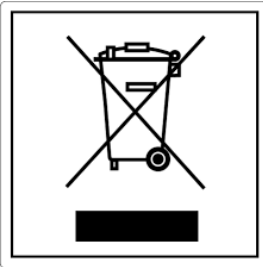

ITA-Informationi per la gestione di rifiuti di apparecchiature elettriche ed elettroniche contenenti pile e accumulatori

Questo simbolo che appare sul prodotto, sulle pile, sugli accumulatori oppure sulla loro confezione o sulla loro documentazione, indica che il prodotto e le pile o gli accumulatori inclusi al termine del ciclo di vita utile non devono essere raccolti, recuperati o smaltiti assieme ai rifiuti domestici.

Una gestione impropria dei rifiuti di apparecchiature elettriche ed elettroniche, di pile o accumulatori può causare il rilascio di sostanze pericolose contenute nei prodotti. Allo scopo di evitare eventuali danni all'ambiente o alla salute, si invita l'utilizzatore a separare questa apparecchiatura, e/o le pile o accumulatori inclusi, da altri tipi di rifiuti e di consegnarla al centro comunale di raccolta. È possibile richiedere al distributore il ritiro del rifiuto di apparecchiatura elettrica ed elettronica alle condizioni e secondo le modalità previste dal D.Lgs. 49/2014.

La raccolta separata e il corretto trattamento delle apparecchiature elettriche ed elettroniche, delle pile e degli accumulatori favoriscono la conservazione delle risorse naturali, il rispetto dell'ambiente e assicurano la tutela

della salute.

Per ulteriori informazioni sui centri di raccolta dei rifiuti di apparecchiature elettriche ed elettroniche, di pile e accumulatori è necessario rivolgersi alle Autorità pubbliche competenti al rilascio delle autorizzazioni.

ENG-Information for management of electric and electronic appliance waste containing batteries or accumulators

This symbol, which is used on the product, batteries, accumulators or on the packaging or documents, means that at the end of its useful life, this product, the batteries and the accumulators included must not be collected, recycled or disposed of together with domestic waste.

Improper management of electric or electronic waste or batteries or accumulators can lead to the leakage of hazardous substances contained in the product. For the purpose of preventing damage to health or the environment, users are kindly asked to separate this equipment and/or batteries or accumulators included from other types of waste and to arrange for disposal by the municipal waste service. It is possible to ask your local dealer to collect the waste electric or electronic appliance under the conditions and following the methods provided by national laws transposing the Directive 2012/19/EU.

Separate waste collection and recycling of unused electric and electronic equipment, batteries and accumulators helps to save natural resources and to guarantee that this waste is processed in a manner that is safe for health and the environment.

For more information about how to collect electric and electronic equipment and appliances, batteries and accumulators, please contact your local Council or Public Authority competent to issue the relevant permits.

FRA-Informations relatives à la gestion des déchets d'appareils électriques et électroniques contenant des piles et des accumulateurs

Ce symbole présent sur le produit, sur les piles, sur les accumulateurs, sur l'emballage ou sur la documentation de référence, indique que le produit et les piles ou les accumulateurs ne doivent pas être collectés, récupérés ou éliminés avec les déchets domestiques au terme de leur vie utile.

Une gestion improprie des déchets d'équipements électriques et électroniques, des piles ou des accumulateurs peut causer la libération de substances dangereuses contenues dans les produits. Pour éviter d'éventuelles atteintes à l'environnement ou à la santé, on invite l'utilisateur à séparer cet appareil, et / ou les piles ou les accumulateurs, des autres types de déchets et de le confier au service municipal de collecte. On peut demander au distributeur de prélever le déchet d'appareil électrique ou électronique aux conditions et suivant les modalités prévues par les normes nationales de transposition de la Directive 2012/19/UE.

La collecte sélective et le traitement correct des appareils électriques et électroniques, des piles et des accumulateurs, favorisent la conservation des ressources naturelles, le respect de l'environnement et assurent la protection de la santé.

Pour tout renseignement complémentaire sur les modalités de collecte des déchets d'appareils électriques et électroniques, des piles et des accumulateurs, il faut s'adresser aux Communes ou aux Autorités publiques compétentes pour la délivrance des autorisations.

NLD-Informatie voor het beheer van afgedankte elektrische en elektronische apparatuur die batterijen en accu's bevat

Dit symbool, dat op het product, op batterijen, op accu's, op de verpakking of in de documentatie ervan staat, geeft aan dat het product en de batterijen of accu's aan het einde van de gebruiksduur niet samen met het huishoudelijke afval mogen worden ingezameld of verwijderd.

Een onjuist beheer van afgedankte elektrische en elektronische apparatuur, batterijen of accu's kan leiden tot het vrijkomen van gevaarlijke stoffen in de producten. Om schade aan het milieu of aan de gezondheid te voorkomen, wordt de gebruiker aangemoedigd om deze apparatuur en/of de meegeleverde batterijen of accu's van andere soorten afval te scheiden en af te leveren aan de gemeentelijke ophaaldienst. Het is mogelijk om de distributeur te vragen om de afvalinzameling van elektrische en elektronische apparatuur uit te voeren volgens de voorwaarden en de voorschriften die zijn vastgelegd in de nationale bepalingen ter uitvoering van Richtlijn 2012/19/EU.

De gescheiden inzameling en correcte behandeling van elektrische en elektronische apparatuur, batterijen en accu's bevorderen het behoud van natuurlijke hulpbronnen, respect voor het milieu en zorgen voor de bescherming van de gezondheid.

Voor meer informatie over de inzameling van afgedankte elektrische en elektronische apparatuur, batterijen en accu's is het noodzakelijk om contact op te nemen met de gemeenten of de bevoegde overheidsinstanties.

DEU-Informationen für die Entsorgung von elektrischen und elektronischen Altgeräten, die Batterien und Akkus enthalten

Dieses Symbol auf dem Produkt, auf den Batterien, auf den Akkus, auf deren Verpackung oder in deren Unterlagen weist darauf hin, dass das Produkt und die Batterien oder Akkus am Ende ihrer Lebensdauer nicht zusammen mit dem normalen Hausmüll gesammelt, verwertet oder entsorgt werden dürfen.

Eine unsachgemäße Entsorgung von elektrischen und elektronischen Altgeräten, sowie von Batterien oder Akkus kann zur Freisetzung gefährlicher Stoffe im Produkt führen. Um mögliche Umwelt- oder Gesundheitsschäden zu vermeiden, wird der Benutzer aufgefordert, dieses Gerät bzw. die Batterien oder Akkus von anderen Abfallarten zu trennen und der kommunalen Sammelstelle zu übergeben. Außerdem ist es möglich, den Händler um die Rücknahme der elektrischen und elektronischen Altgeräte unter den in den nationalen Vorschriften zur Umsetzung der Richtlinie 2012/19/EU vorgesehenen Bedingungen zu bitten.

Die getrennte Sammlung und die ordnungsgemäße Verwertung von elektrischen und elektronischen Altgeräten, Batterien und Akkus fördert die Erhaltung der natürlichen Ressourcen, respektiert die Umwelt und gewährleistet den Schutz der Gesundheit.

Für weitere Informationen zur Sammlung von elektrischen und elektronischen Altgeräten, Batterien und Akkus wenden Sie sich bitte an die für die Erteilung von Genehmigungen zuständigen Kommunen oder Behörden.

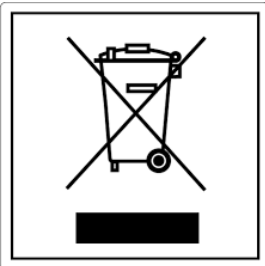

ESP-Información para la gestión de residuos de aparatos eléctricos y electrónicos con pilas y acumuladores

Este símbolo que aparece en el producto, en las pilas, los acumuladores o en su embalaje o su documentación indica que el producto y las pilas o acumuladores que contiene, al final de su vida útil, no deben recogerse, recuperarse o desecharse junto con los residuos domésticos.

Una gestión inadecuada de los residuos de aparatos eléctricos y electrónicos, pilas o acumuladores podría provocar la liberación de sustancias peligrosas contenidas en los productos. Para evitar posibles daños para el medio ambiente o la salud, se recomienda al usuario que separe este aparato y/o las pilas o acumuladores que contiene de otros tipos de residuos y lo entregue al servicio municipal encargado de la recogida. Se puede solicitar al distribuidor la recogida de los residuos de aparatos eléctricos y electrónicos en las condiciones y de acuerdo con las modalidades establecidas por las normas nacionales de transposición de la Directiva 2012/19/UE.

La recogida diferenciada y el tratamiento correcto de los aparatos eléctricos y electrónicos, de las pilas y los acumuladores favorecen la conservación de los recursos naturales, el respeto del medio ambiente y garantizan la protección de la salud.

Para obtener más información sobre las modalidades de recogida de los residuos de aparatos eléctricos y electrónicos, de las pilas y los acumuladores es necesario acudir a los ayuntamientos o las autoridades públicas competentes para la concesión de autorizaciones.

PRT-Informações sobre a gestão dos resíduos de equipamentos elétricos e eletrônicos contendo pilhas e acumuladores

Este símbolo no produto, pilhas, acumuladores ou respetiva embalagem ou documentação indica que, no final do seu ciclo de vida útil, o produto e os acumuladores incluídos não devem ser recolhidos, recuperados nem eliminados conjuntamente com o lixo doméstico.

Uma gestão imprópria dos resíduos de equipamentos elétricos e eletrônicos, pilhas ou acumuladores pode causar a libertação de substâncias perigosas contidas nos produtos. A fim de evitar eventuais danos para o ambiente ou para a saúde, o utilizador é convidado a separar este equipamento e/ou pilhas ou acumuladores incluídos de outros tipos de resíduos e a depositá-los no serviço municipal de recolha de lixo. É possível requisitar a recolha dos resíduos de equipamentos elétricos e eletrônicos pelo distribuidor segundo as condições e modalidades previstas pelas normas nacionais de transposição da diretiva 2012/19/UE.

A recolha separada e o correto tratamento dos equipamentos elétricos e eletrônicos e respetivas pilhas e acumuladores favorecem a conservação dos recursos naturais, o respeito do ambiente e a proteção da saúde.

Para mais informações sobre as modalidades de recolha dos resíduos de equipamentos elétricos e eletrônicos, pilhas e acumuladores, dirija-se à sua Câmara Municipal ou à autoridade pública competente para a emissão das autorizações.

GRC-Πληροφορίες για τη διαχείριση αποβλήτων ηλεκτρικού και ηλεκτρονικού εξοπλισμού, μπαταριών και συσσωρευτών

Αυτό το σύμβολο που εμφανίζεται στο προϊόν, στις μπαταρίες, στους συσσωρευτές στη συσκευασία ή στα έγγραφα υποδεικνύει ότι το προϊόν στο τέλος της ωφέλιμης ζωής του δεν πρέπει να συλλέγεται, να ανασύρεται ή να απορρίπτεται με τα οικιακά απορρίμματα.

Ο ακατάλληλος χειρισμός των αποβλήτων ηλεκτρικού και ηλεκτρονικού εξοπλισμού, μπαταριών ή συσσωρευτών μπορεί να οδηγήσει στην απελευθέρωση επικίνδυνων ουσιών που περιέχονται στο προϊόν. Προκειμένου να αποφευχθεί τυχόν μόλυνση στο περιβάλλον ή ασθένεια, ο χρήστης ενθαρρύνεται να διαχωρίσει αυτόν τον εξοπλισμό ή/και τις μπαταρίες ή τους συσσωρευτές που περιλαμβάνονται από άλλα είδη αποβλήτων και να το παραδώσει στην υπηρεσία δημοτικών συλλογών. Είναι δυνατόν να ζητηθεί από τον διανομέα η συλλογή αποβλήτων ηλεκτρικού και ηλεκτρονικού εξοπλισμού που πρέπει να πραγματοποιηθεί σύμφωνα με τους όρους και με τις διαδικασίες που θεσπίζονται από τις εθνικές διατάξεις εφαρμογής της οδηγίας 2012/19/ΕΕ.

Η χωριστή συλλογή και η σωστή επεξεργασία ηλεκτρικού και ηλεκτρονικού εξοπλισμού, μπαταριών και συσσωρευτών ευνοούν τη διατήρηση των φυσικών πόρων, τον σεβασμό για το περιβάλλον και την προστασία της υγείας.

Για περισσότερες πληροφορίες σχετικά με τον τρόπο συλλογής των αποβλήτων ηλεκτρικού και ηλεκτρονικού εξοπλισμού, μπαταριών και συσσωρευτών είναι απαραίτητο να επικοινωνήσετε με τους δήμους ή τις δημόσιες αρχές που είναι αρμόδιες για την έκδοση των αδειών.

DNK-Informationer til behandling af affald fra elektriske og elektroniske udstyr der indeholder batterier og akkumulatorer

Dette symbol, der vises på produktet, på batterierne eller på akkumulatorerne, på indpakningen eller i dokumentationen, angiver at selve produkt, når dets levetid er opbrugt, ikke skal opsamles, genvindes eller bortskaffes sammen med normalt husholdningsaffald.

En ukorrekt behandling af affald fra elektriske eller elektroniske udstyr, af batterier og akkumulatorer, risikerer at udlede farlige stoffer indeholdt i produktet. For at forebygge ventuelle skader for miljøet eller sundheden, bedes brugeren om at behandle dette udstyr, og/eller de medfølgende batterier eller akkumulatorerne separat fra andre affaldstyper, og at levere det til det kommunale opsamlingscenter, eller at anmode leverandøren om opsamling, i henhold til forskrifterne, der er angivet i de nationale forordninger til gennemførelse af Direktivet 2012/19/EF.

Den separate opsamling og genvinding af de nedslidte elektriske og elektroniske udstyr, af batterierne og af akkumulatorerne, fremmer bevarelsen af de naturlige ressourcer, og sikrer at dette affald behandles ved at tage hensyn til miljøets og sundhedens varetagelse.

Til yderligere informationer angående opsamling af affald fra elektriske og elektroniske udstyr, af batterier og akkumulatorer, er det nødvendigt at rette henvendelse til Kommunerne eller til de ansvarlige myndigheder til udstedelse af bemyndigelserne.

POL-Informacje dotyczące zarządzania odpadami sprzętu elektrycznego i elektronicznego zawierającego baterie i akumulatory

Niniejszy symbol znajdujący się na produkcie, bateriach, akumulatorach, na ich opakowaniu lub na dokumentacji, wskazuje, że produkt, baterie lub akumulatory po zakończeniu okresu użytkowania nie mogą być zbierane, odzyskiwane lub utylizowane wraz z odpadami komunalnymi.

Niewłaściwe postępowanie ze użytym sprzętem elektrycznym i elektronicznym, bateriami lub akumulatorami może powodować uwolnienie niebezpiecznych substancji zawartych w produktach. Celem uniknięcia jakichkolwiek szkód dla środowiska lub zdrowia, użytkownik proszony jest o odseparowanie niniejszego sprzętu i/lub dołączonych baterii lub akumulatorów od innych rodzajów odpadów i dostarczenia go do miejskiego punktu zbierania odpadów. Możliwe jest zwrócenie się z prośbą do dystrybutora o odebranie odpadów sprzętu elektrycznego i elektronicznego, na warunkach i zgodnie z procedurami ustanowionymi przez przepisy krajowe transponujące dyrektywę 2012/19/UE.

Oddzielna zbiórka i prawidłowe przetwarzanie sprzętu elektrycznego i elektronicznego, baterii i akumulatorów sprzyja ochronie zasobów naturalnych, poszanowaniu środowiska i zapewnieniu ochrony zdrowia.

Aby uzyskać więcej informacji dotyczących zbiórki użytego sprzętu elektrycznego i elektronicznego, baterii i akumulatorów, należy skontaktować się z władzami miejskimi lub organami publicznymi odpowiedzialnymi za wydawanie zezwoleń.

SVN-Informacije o ravnanju z odpadno električno in elektronsko opremo, ki vsebuje baterije in akumulatorje

Ta simbol, ki se nahaja na izdelku, baterijah, akumulatorjih ali na njihovi embalaži ali v dokumentaciji, označuje, da se po izteku življenjske dobe izdelka ter baterij ali akumulatorjev, ki jih izdelek vsebuje, ne sme zbirati, predelati ali odstranjevati skupaj z odpadki iz gospodinjstev.

Neprimerno ravnanje z odpadno električno in elektronsko opremo, baterijami ali akumulatorji lahko povzroči izpust nevarnih snovi, ki jih vsebujejo izdelki. Da bi preprečili morebitne škodljive vplive na okolje ali zdravje, uporabnike pozivamo, da tovrstno opremo in/ali baterije ali akumulatorje, ki jih oprema vsebuje, ločujejo od drugih vrst odpadkov ter jih oddajo občinski službi za zbiranje odpadkov. Od distributerja lahko zahtevate prevzem odpadne električne in elektronske opreme pod pogoji in na načine, skladno s katerimi je bila Direktiva 2012/19/EU prenesena v nacionalno zakonodajo.

Ločevanje in ustrezna obdelava električnih in elektronskih naprav, baterij in akumulatorjev pripomoreta k ohranjanju naravnih virov, spoštovanju okolja ter zagotavljanju varovanja zdravja.

Za dodatne informacije o načinih zbiranja odpadne električne in elektronske opreme, baterij in akumulatorjev se obrnite na občine ali na javne organe, ki so pristojni za izdajanje dovoljenj.



Aico S.p.A.

Headquarter

Via Consorzio Agrario, 3/D - 25032
Chiari (BS) - Italy

Research and Development Centre

Viale del commercio 12/a - 37135
Verona (VR) - Italy

T. + 39 030 7402939
info@ravelligroup.it

FB Ravellifuocointelligente
IG ravellistufe

www.ravelligroup.it

Aico S.p.A. does not assume any responsibility for any errors in this booklet and considers itself free to make any variations to the features of its products without notice.